

V-SERIES ELECTRICAL SETUP & COMMISSIONING GUIDE



**VECTOR 2
VERT-X
V400/V500**

Company Profile



In-house R&D development team



100% testing of products

Manufacture to international quality standard ISO 9001:2008

After-sales multi-language Technical Support from 07h00 to 18h00 UTC+2 Monday to Friday



Sales and technical support to Africa, Europe, Asia, the Americas, Australia and the Pacific

Centurion Systems (Pty) Ltd reserves the right to make changes to the products described in this manual without notice and without obligation of **Centurion Systems (Pty) Ltd** to notify any persons of any such revisions or changes. Additionally, **Centurion Systems (Pty) Ltd** makes no representations or warranties with respect to this manual. No part of this document may be copied, stored in a retrieval system or transmitted in any form or by any means electronic, mechanical, optical or photographic, without the express prior written consent of **Centurion Systems (Pty) Ltd**.



Contents

SAFETY FIRST

IMPORTANT SAFETY INSTRUCTIONS

page 5

1. General Description	page 7
1.1. Lightning Protection	page 8
2. Icons Used in this Manual	page 9
3. Electrical Setup	page 10
4. Wiring Diagram Symbols	page 15
5. Wiring Diagram - Master Motor (MTR M)	page 16
6. Wiring Diagram - Slave Motor (MTR S)	page 17
7. Wiring Diagram - Wired Closing Safety Beams	page 18
8. Wiring Diagram - Double Wired Closing Safety Beams	page 19
9. Wiring Diagram - Wired Opening Safety Beams	page 20
10. Wiring Diagram - Wireless Closing Safety Beams	page 21
11. Wiring Diagram - Double Wireless Closing Safety Beams	page 22
12. Wiring Diagram - Wireless Opening Safety Beams	page 23
13. Wiring Diagram - External Radio Receiver & Loop Detector	page 24
14. Wiring Diagram - Electric Gate Lock/Maglock	page 25
15. Wiring Diagram - Holiday Lockout Keyswitch/Keypad	page 26
16. Wiring Diagram - Pedestrian Keyswitch/Keypad	page 27
17. Wiring Diagram - G-SPEAK Classic+ Intercom	page 28
18. Wiring Diagram - G-SWITCH-22 Monitoring & Control Device	page 29
19. Wiring Diagram - Status LED	page 30
20. Wiring Diagram - Solar Panel	page 31
21. Wiring Diagram - Pillar Light Push button (Normally-Open)	page 32
22. Wiring Diagram - Charger & Pillar Light Connections	page 33
22.1. Fuse Protection	page 34
23. Setting up Additional Features	page 35
24. Controller Menu Structure	page 36
25. Controller Features	page 40

26. Factory Defaults Schedule	page 56
26.1. South African Standard Profile - ZA	page 56
26.2. CE Standard Profile	page 59
26.3. UL325 Standard Profile	page 62
27. Description of Terminal Functions	page 65
28. Diagnostics	page 68
28.1. Diagnostic LEDs	page 68
28.2. Gate Status LED Indication	page 69
28.3. LCD Display	page 70
28.4. Buzzer Feedback	page 71
29. Installation Handover	page 72

IMPORTANT SAFETY INSTRUCTIONS

ATTENTION

To ensure the safety of people and possessions, it is important that you read all the following instructions.

Incorrect installation or incorrect use of the product could cause serious harm to people and pets.



The installer, being either professional or DIY, is the last person on the site who can ensure that the operator is safely installed, and that the whole system can be operated safely.

Warnings for the Installer

CAREFULLY READ AND FOLLOW ALL INSTRUCTIONS before beginning to install the product.

- All installation, repair, and service work to this product must be done by a suitably qualified person
- Do not activate your gate opener unless you can see it and can determine that its area of travel is clear of people, pets, or other obstructions
- **NO ONE MAY CROSS THE PATH OF A MOVING GATE.** Always keep people and objects away from the gate and its area of travel
- **NEVER LET CHILDREN OPERATE OR PLAY WITH THE GATE CONTROLS,** and do not allow children or pets near the gate area
- Secure all easily-accessed gate opener controls in order to prevent unauthorised use of the gate
- Do not in any way modify the components of the automated system
- Do not install the equipment in an explosive atmosphere: the presence of flammable gas or fumes is a serious danger to safety
- Before attempting any work on the system, switch off electrical power and disconnect the batteries
- The mains power supply of the automated system must be fitted with an all-pole switch with contact opening distance of 3mm or greater. Use of a 5A hydraulic breaker with all-pole circuit break is recommended
- Make sure that an earth leakage circuit breaker with a threshold of 30mA is fitted upstream of the system
- Never short-circuit the battery and do not try to recharge the batteries with power supply units other than that supplied with the product, or by Centurion Systems (Pty) Ltd
- Make sure that the earthing system is correctly constructed, and that all metal parts of the system are suitably earthed
- Safety devices must be fitted to the installation to guard against mechanical movement risks such as crushing, dragging and shearing

- It is recommended that at least one warning indicator light be fitted to every system
- Always fit the warning signs visibly to the inside and outside of the gate
- The installer must explain and demonstrate the manual operation of the gate in the case of an emergency, and must hand the User/Warnings guide over to the user
- The installer must explain these safety instructions to all persons authorised to use this gate, and be sure that they understand the hazards associated with automated gates
- Do not leave packing materials (plastic, polystyrene, etc.) within reach of children as such materials are potential sources of danger
- Dispose of all waste products such as packing materials, worn-out batteries, etc., according to local regulations
- Always check the obstruction detection system and safety devices for correct operation
- Centurion Systems (Pty) Ltd does not accept any liability caused by improper use of the product, or for use other than that for which the automated system was intended
- This product was designed and built strictly for the use indicated in this documentation. Any other use, not expressly indicated here, could compromise the service life/operation of the product and/or be a source of danger
- Everything not expressly specified in these instructions is not permitted



- **Never run the operator directly from the battery! Doing so will cause damage to the operator. Only run the operator from the V-Series Controller**
- **A moving gate can cause serious injury or death! Keep clear! The gate may move at any time! Do not allow children to play in the area of travel of the gate or operate the gate**

1. General Description

The **V400/V500, VERT-X and VECTOR2** operators have been designed to safely and cost-effectively automate a wide variety of swing gates, from single light-domestic swing gates to heavy industrial double swing gates.

The fail-safe and fully-redundant Position and Collision Detection system has been designed and tested to set the standard in safety of operation and to provide an unparalleled level of reliability and durability in operation.

The gate Travel Limits are managed by a sealed double-redundant opto-electronic system that has been designed not only to ensure ultra-reliable operation, but also to ensure precise position and trajectory control. This enables very accurate and reliable collision detection to ensure safe operation even under trying conditions.

The **V-Series electronic Controller** has been designed to be easy and intuitive to use, with helpful instructions on the status of the operation being given both during and after the installation. It also has built-in diagnostic procedures that can verify every aspect of the control card onsite.

Some of the advanced features offered by the **V-Series Controller** are:

- Fully automated single-button Limit Setup for single and double swing gates
- Full graphics LCD display provides an intuitive user interface with built-in diagnostics to speed up and simplify the installation process
- Separate safety inputs for infrared beams or photocells on both the closing and opening directions of the gate
- Advanced closed-loop speed control to maintain safe and reliable operation on inclined gates and under windy conditions
- Fully-configurable gate Run Profiles
- Selectable and adjustable Autoclose with push button override
- Pedestrian Opening (partial opening) with Autoclose
- Free-exit input
- Positive Close Mode
- Positive Open Mode
- Support for Inward and Outward opening gates
- Multiple Modes of Operation
- Solenoid lock drive output up to 2A
- Holiday Lockout
- A status LED output to indicate the Gate Status remotely
- Pillar Light Control
- Leaf Delay is selectable for either gate leaf
- Onboard code-hopping receiver with selective adding and deleting of remote controls

This guide covers all aspects pertaining to the electrical setup of your new **V400/V500, VERT-X or VECTOR2** swing gate operators, including wiring and configuring the various features and functions available on the controller.

1.1. Lightning Protection

The **V-Series Controller** utilises the same proven surge protection philosophy that is used in all of our products. While this does not guarantee that the unit will not be damaged in the event of a lightning strike or power surge, it greatly reduces the likelihood of such damage occurring. The earth return for the surge protection is provided via the mains power supply earth. In order to ensure that the surge protection is effective, it is essential that the unit is properly earthed.

2. Icons Used in this Manual



This icon indicates tips and other information that could be useful during the installation.



This icon denotes variations and other aspects that should be considered during installation.



This icon indicates warning, caution or attention! Please take special note of critical aspects that MUST be adhered to in order to prevent injury.

3. Electrical Setup

1. Always check that the circuit breaker in the electrical panel is in the OFF position, and that all high-voltage circuits (more than 42.4V) are completely isolated from the mains supply before doing any work.
2. Ensure that all low-voltage systems (less than 42.4V) are suitably protected from damage, by disconnecting all sources of power such as chargers and batteries before doing any work.
3. All electrical work must be carried out according to the requirements of all applicable local electrical codes.



3.1. Secure V-Series Wall Box to Wall

Secure the V-Series Wall Box to the wall using the most appropriate means.

Be sure to position the Wall Box so as not to cause any hazards during and after the installation. Preferably mount the Wall Box:

- Out of direct sunlight
- At a comfortable working height
- Away from garden sprinklers, etc.
- To allow easy access even when the gate is open



FIGURE 1

3.2. Connect all Wiring

Connect all the required cables to the Controller; see pages 16 to 33.



FIGURE 2

When wiring each operator back to the Controller housing, it is recommended to mount a small junction box adjacent to each operator. Terminate the cable provided on the operator into this junction box and then route a new cable from the junction box to the Controller housing.

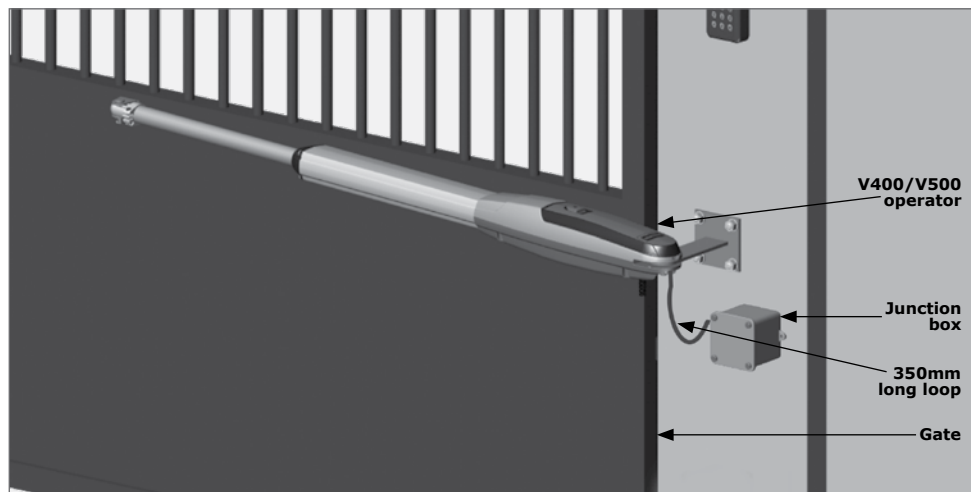

FIGURE 3



- It is essential that the cable is tied off in such a way that a loop 350mm long is formed between where the cable exits the back of the operators, and either the mounting bracket or Wall Box, in order to minimise flexing of the cable
- If a sharp bend is introduced to the cable, or a loop that is less than 350mm in length is used, the resulting cable fatigue, or excessive tension on the cable, may cause the operators to behave erratically or to stop operating altogether

Check that the charger and battery are connected to the Controller.



Ensure that the battery polarity is correct.

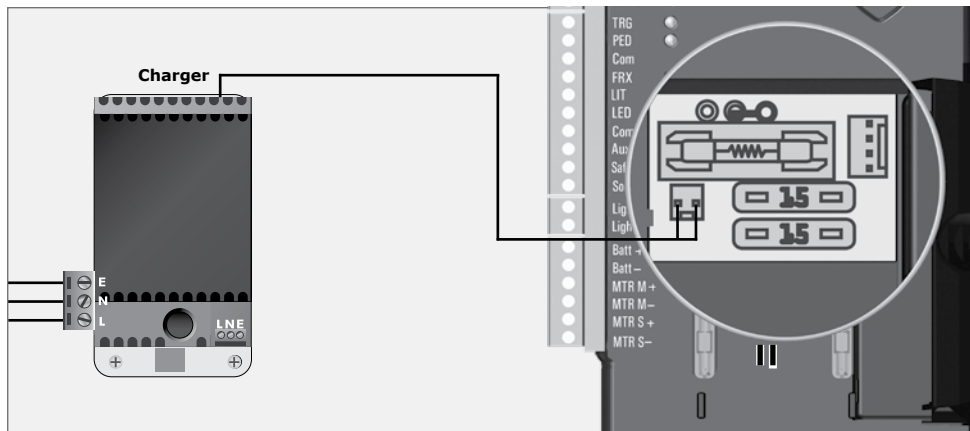

FIGURE 4

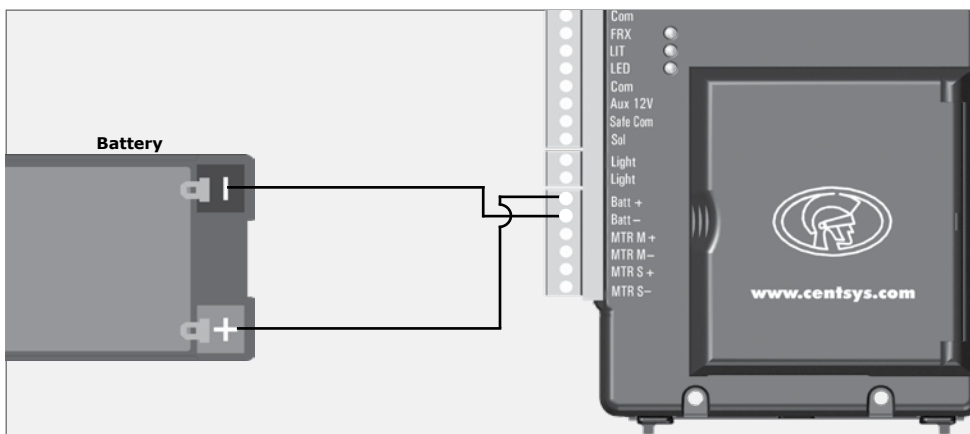

FIGURE 5

Switch on the mains supply (via isolator).

Ensure that both the Controller and charger are effectively earthed for improved lightning protection.

3.3. Setting the Limits

Ensure that the mechanical setup procedure for your operator (**V400/V500**, **VERT-X** or **VECTOR2**) is completed before proceeding with the electronic limit setup. See the Mechanical Installation Manuals.

3.3.1. For an Inward Opening Swing Gate:

Disengage the operator(s) and manually push the gate(s) to the desired closed position.

Engage the operator(s).

3.3.2. For an Outward Opening Swing Gate:

Disengage the operator(s) and manually push the gate(s) to the desired fully open position.

3.3.3. Activate Automatic Limit Setup Procedure:

Engage the operator(s).



Closed lock indicates an operator is in the engaged state.

If powering up the system ex-factory, it will request for the Operating Profile (Operating Standard) to be set; select from the list the Profile that will suit the specific region.

With this set, the system will automatically proceed to the Limit Setup Menu; follow the on-screen instructions to complete the Setup Procedure.

If powering up with the Profile set but no limits set, the system will automatically proceed to the Limit Setup Menu; follow the on-screen instructions to complete the setup procedure.

If powering up at any stage after that, push and hold the Setup button () for three seconds.



- Select the 'Limits' menu by pressing the enter button ()
- Follow the on-screen instructions to complete the setup procedure
- When prompted to select the operator, always ensure that the correct operator '**V400/V500/VERT-X/VECTOR2**' is selected

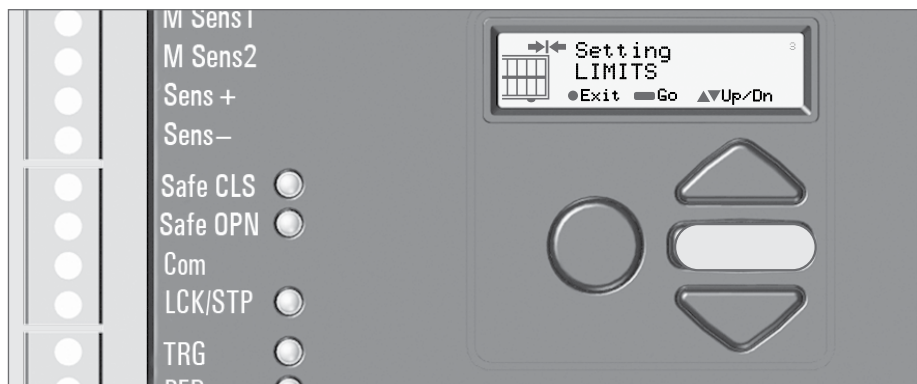

FIGURE 6



Safety devices are not operational during Setup

4. Wiring Diagram Symbols

The Wiring diagrams depicted on the following pages show the wiring of the **V400/ V500/ VERT-X/VECTOR2** Master and Slave Motors back to the **V-Series Controller**, as well as the wiring of the most commonly used ancillary devices to the **V-Series Controller**. Where applicable, an icon has also been provided to indicate whether the connection should be Normally-Open or Normally-Closed.

The icons used as well as their denotive meanings are given in the following section.

Symbols

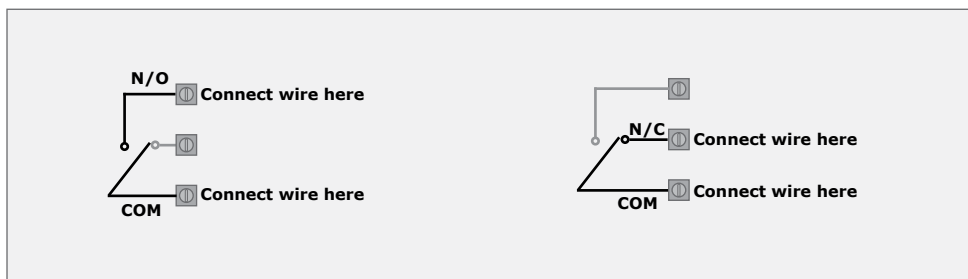

5. Master Motor (MTR M)

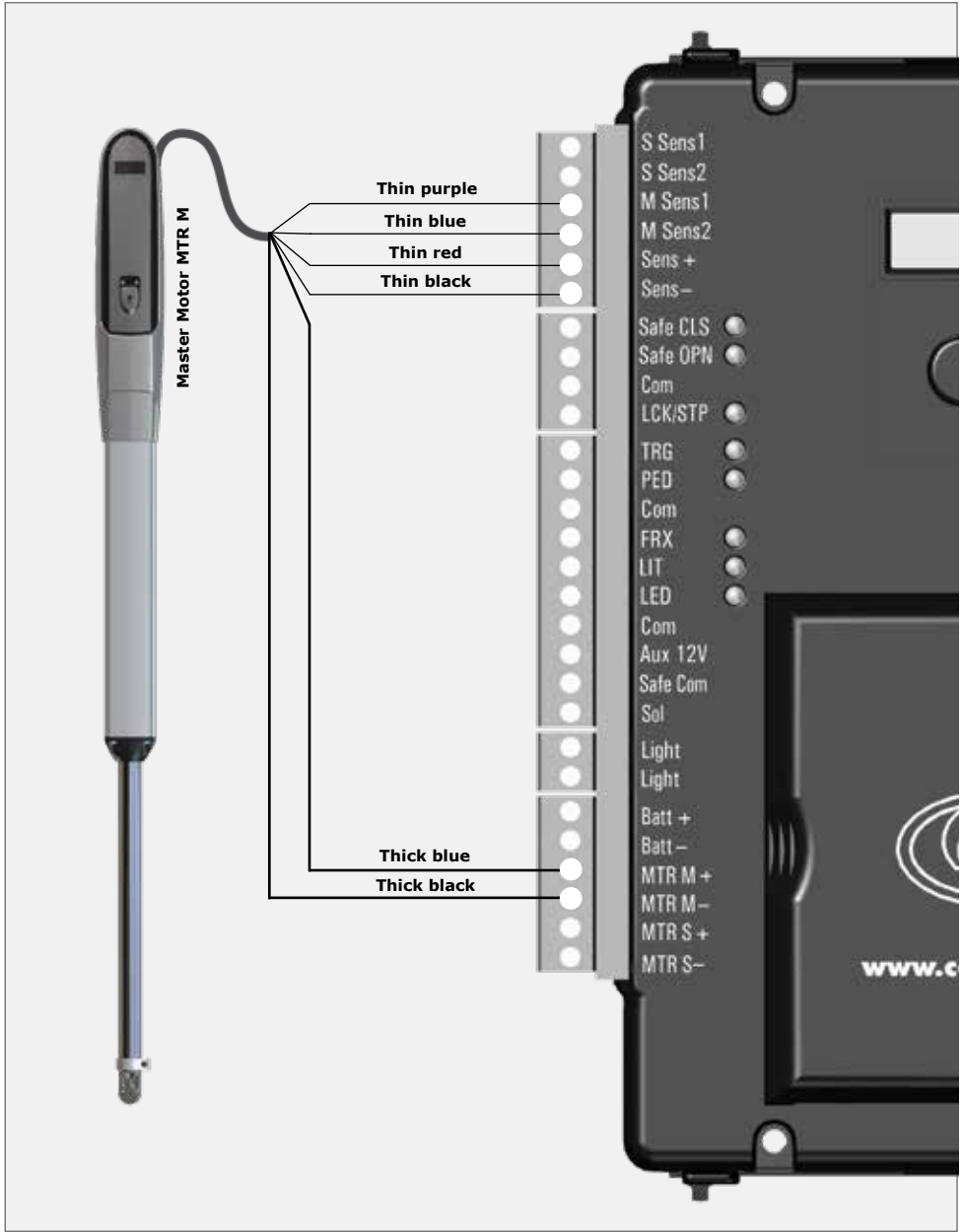

FIGURE 7. MASTER MOTOR (MTR M)

6. Slave Motor (MTR S)

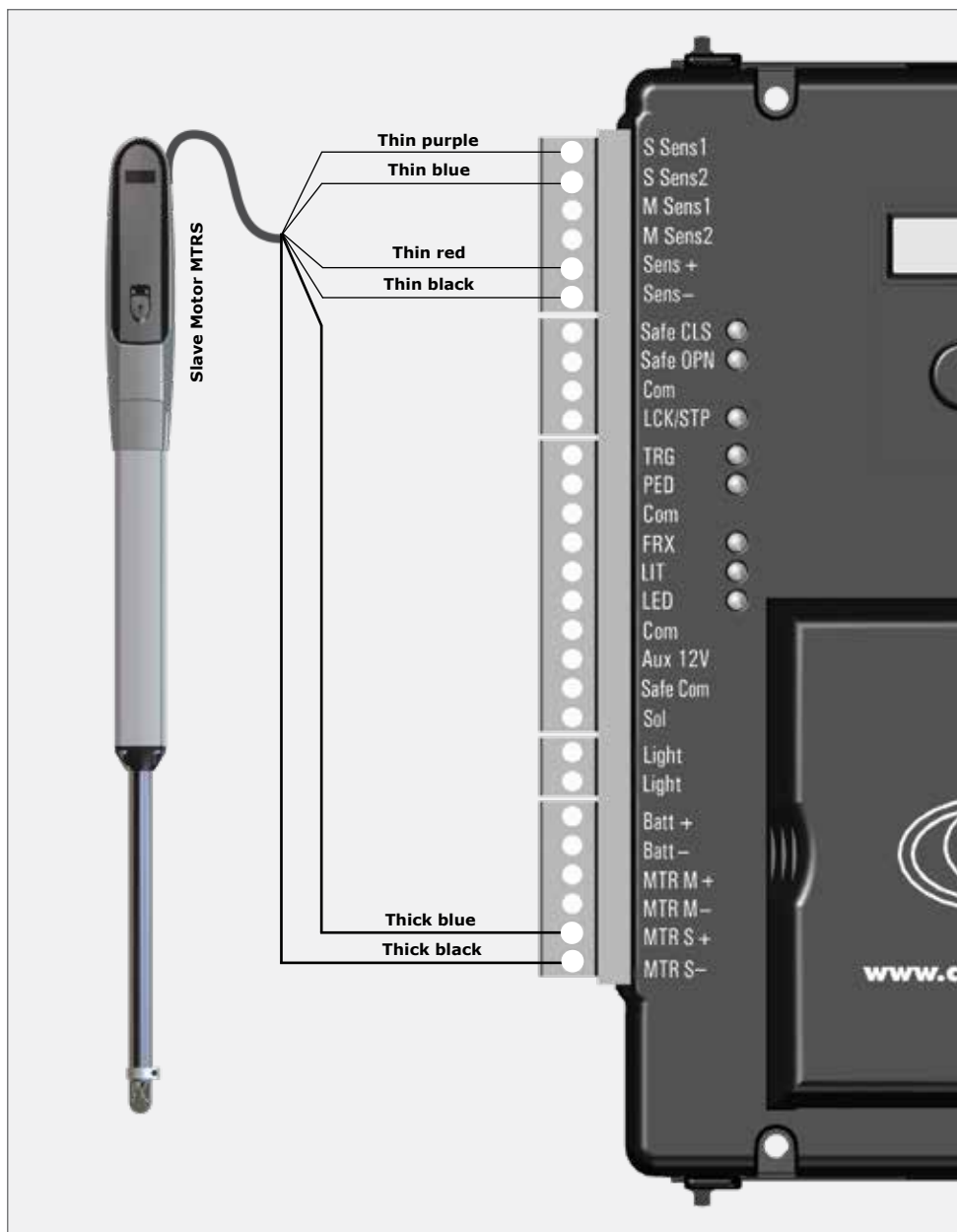

FIGURE 8. SLAVE MOTOR (MTR S)

7. Wired Closing Safety Beams

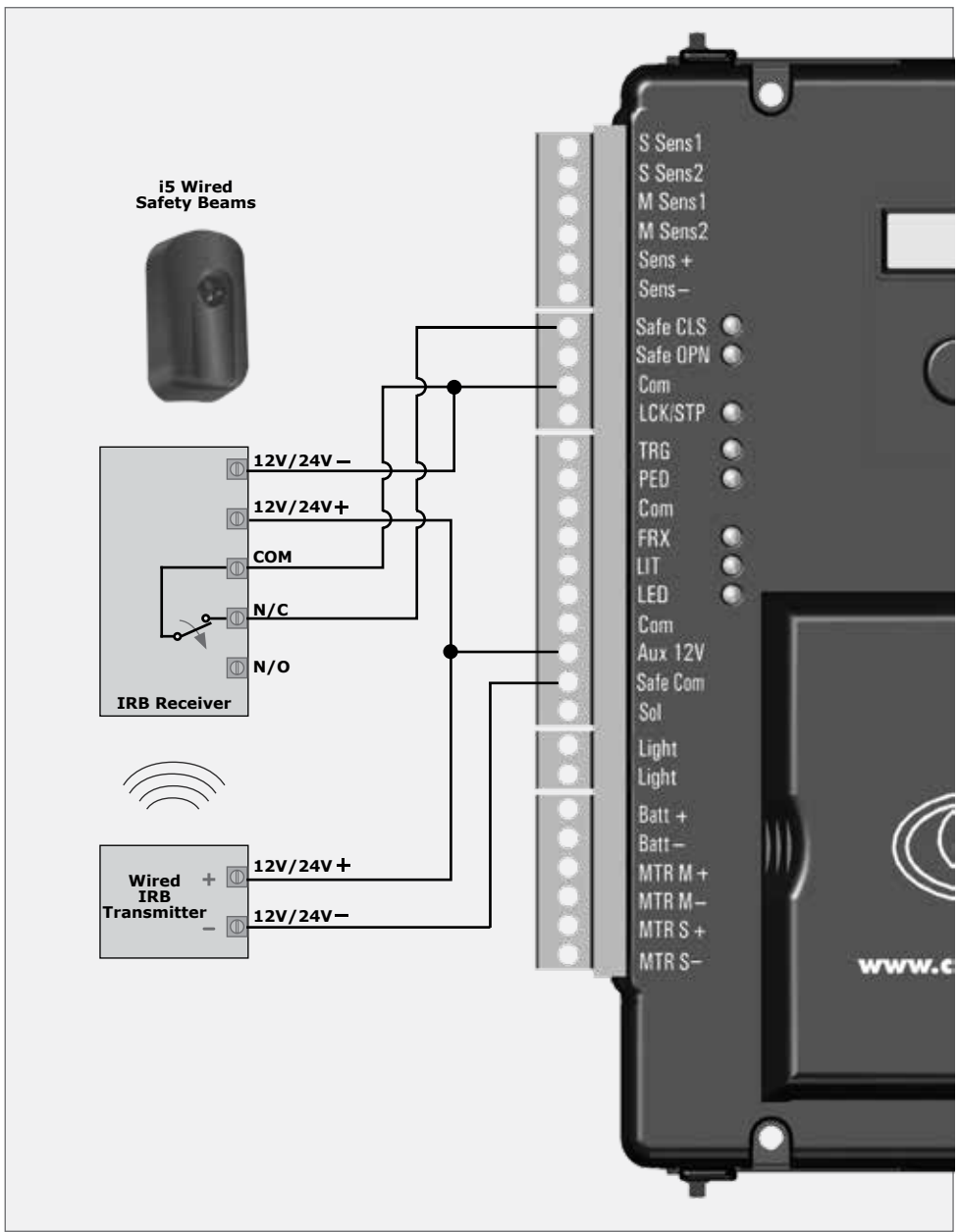

FIGURE 9. WIRED CLOSING SAFETY BEAMS

8. Double Wired Closing Safety Beams

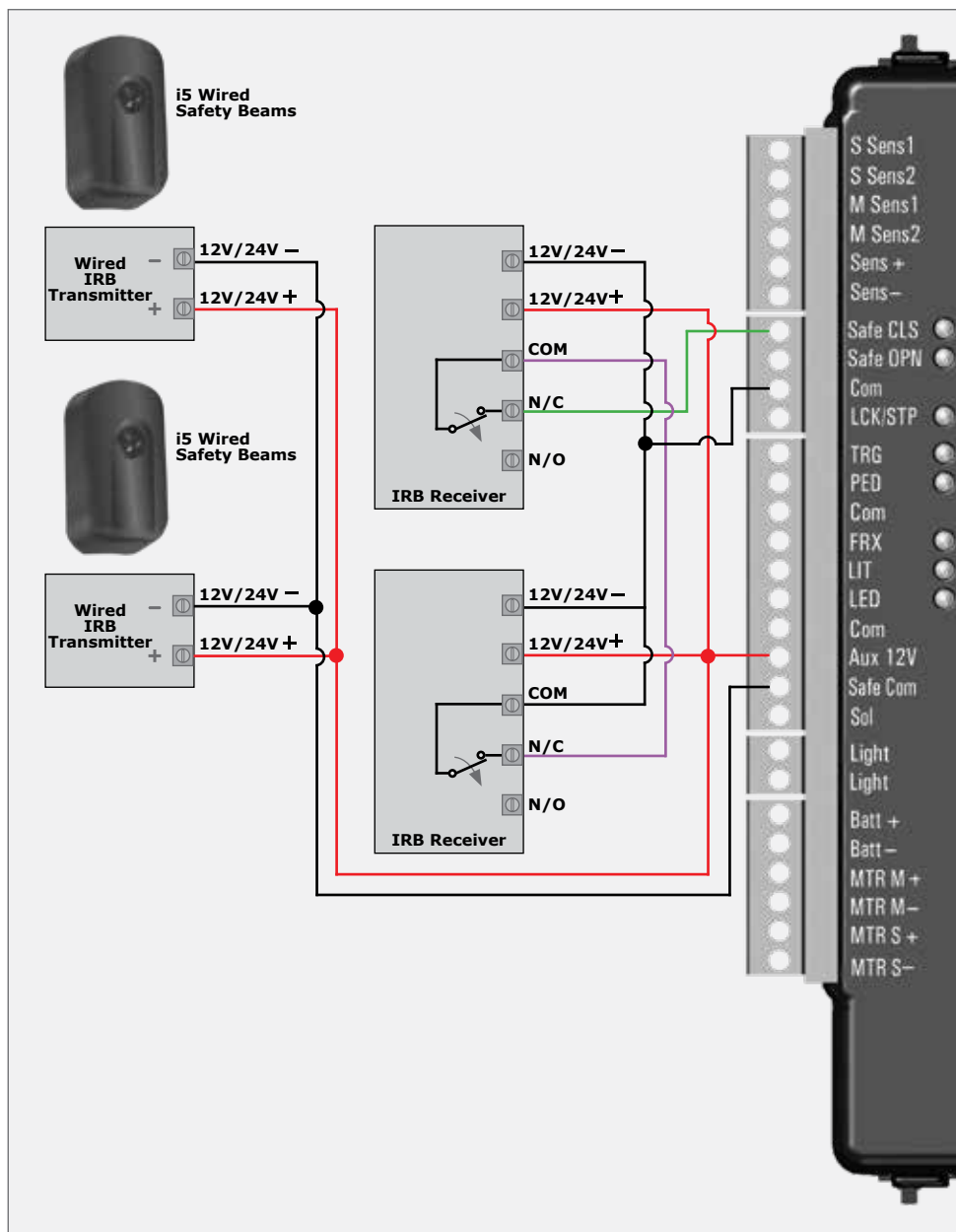

FIGURE 10. DOUBLE WIRED CLOSING SAFETY BEAMS

9. Wired Opening Safety Beams

i5 Wired Safety Beams

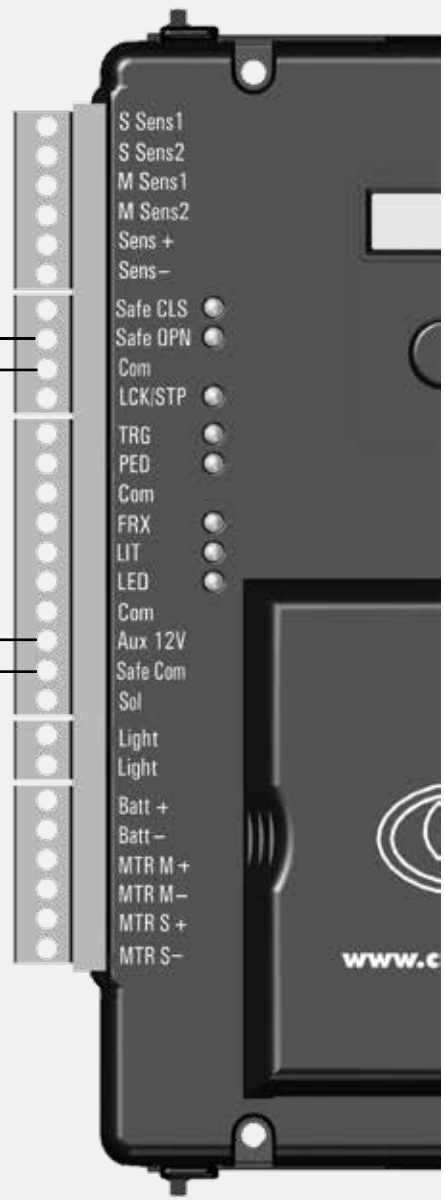
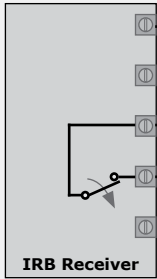

FIGURE 11. WIRED OPENING SAFETY BEAMS

10. Wireless Closing Safety Beams

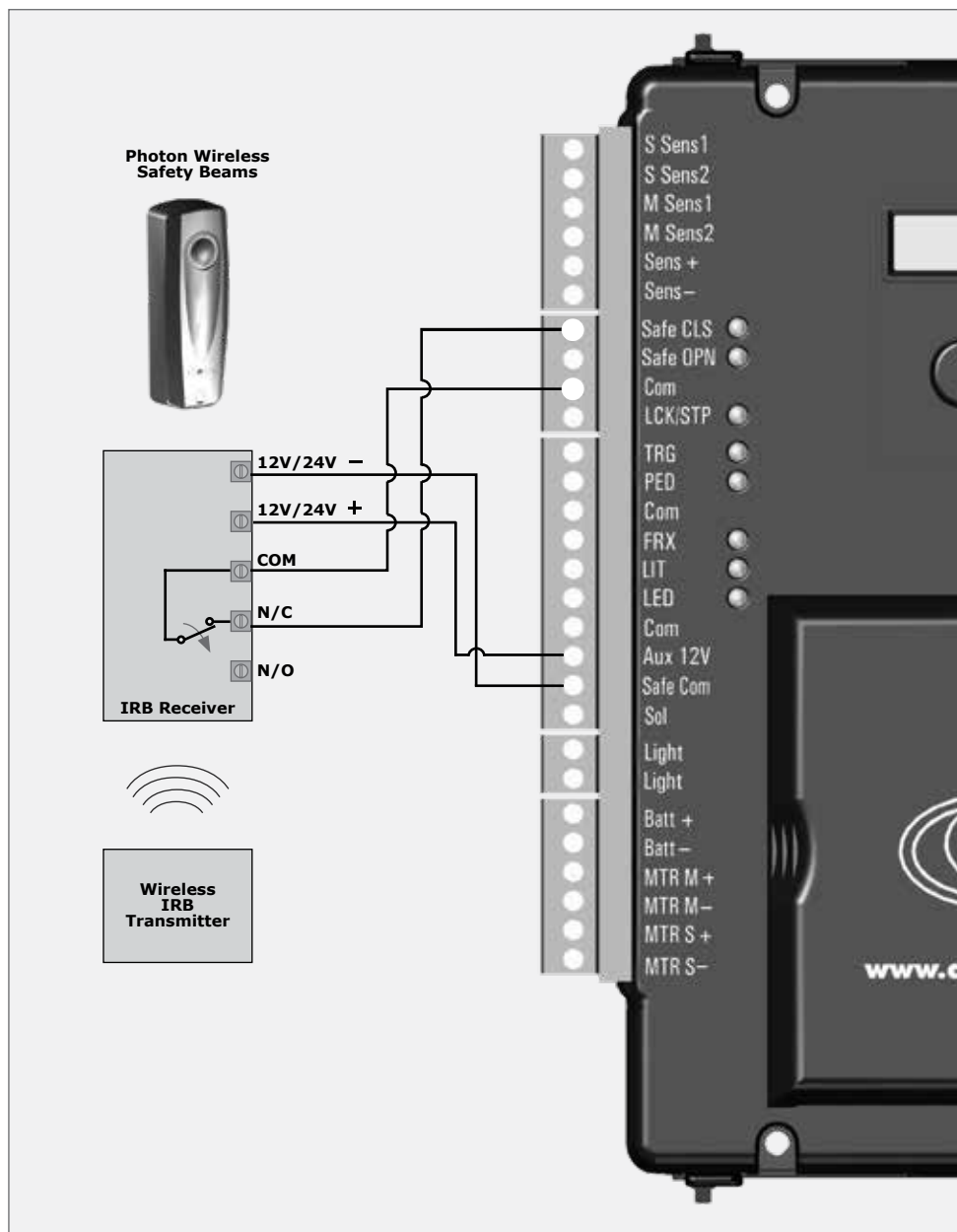

FIGURE 12. WIRELESS CLOSING SAFETY BEAMS

11. Double Wireless Closing Safety Beams

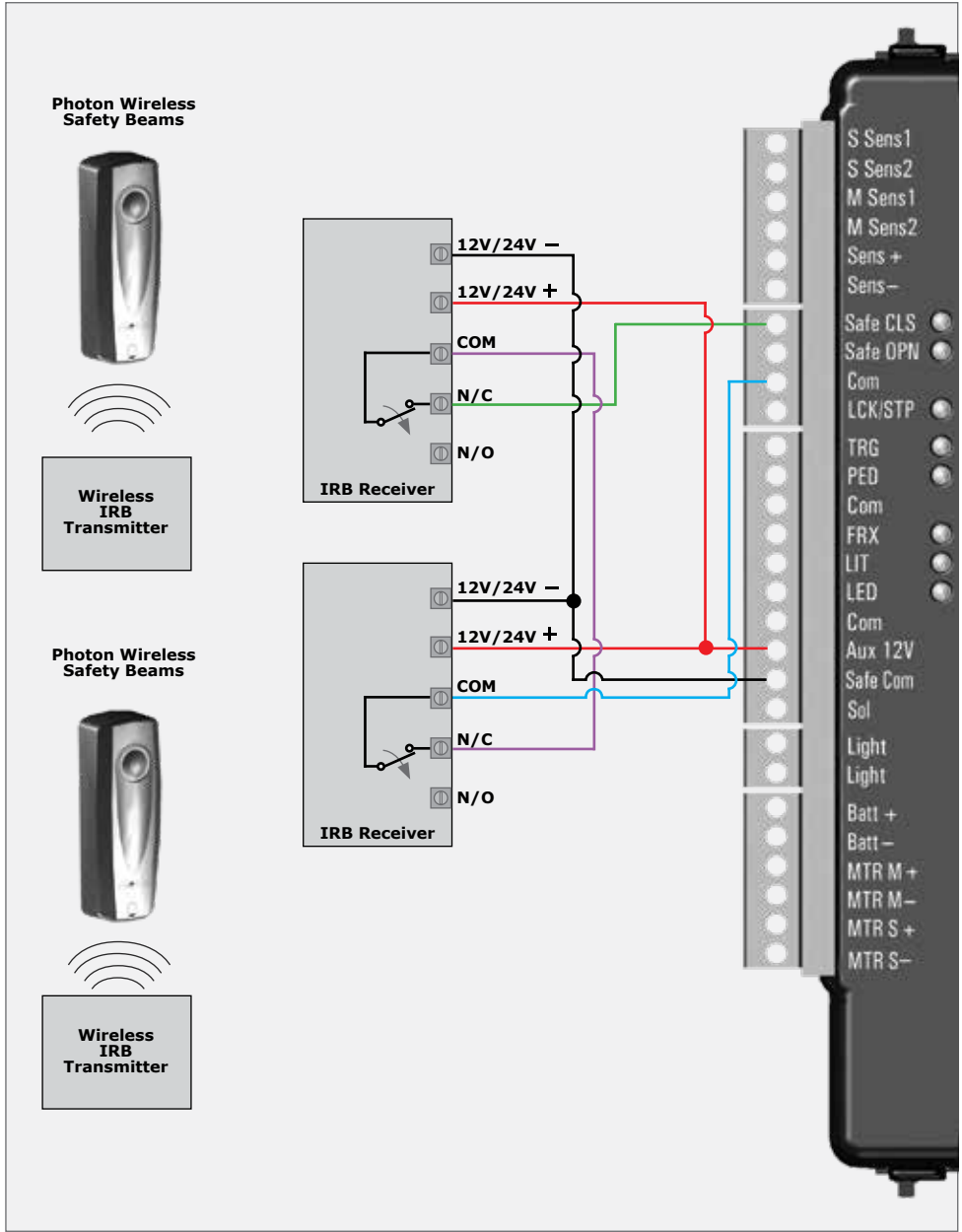

FIGURE 13. WIRELESS CLOSING SAFETY BEAMS

12. Wireless Opening Safety Beams

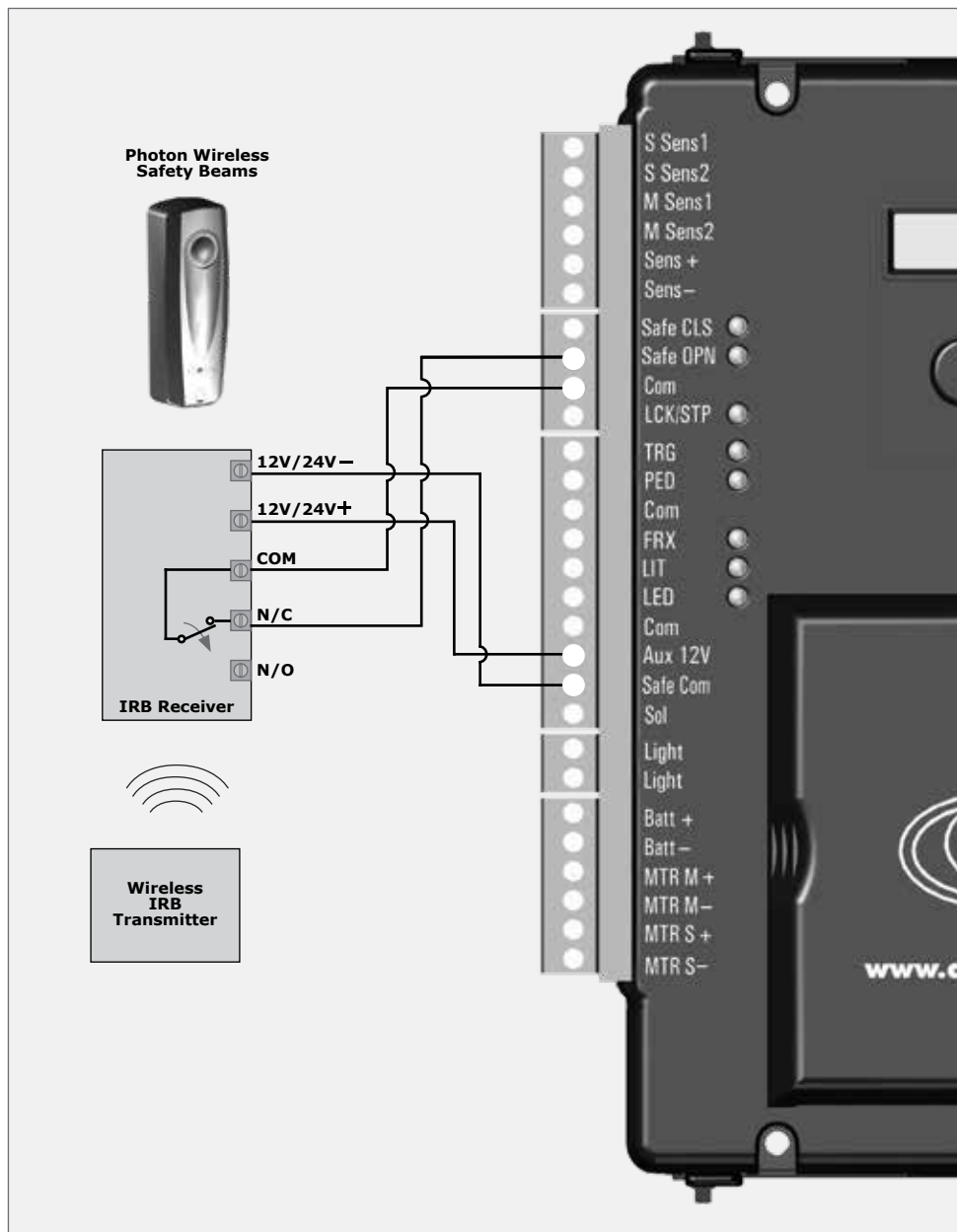

FIGURE 14. WIRELESS OPENING SAFETY BEAMS

13. External Radio Receiver & Loop Detector

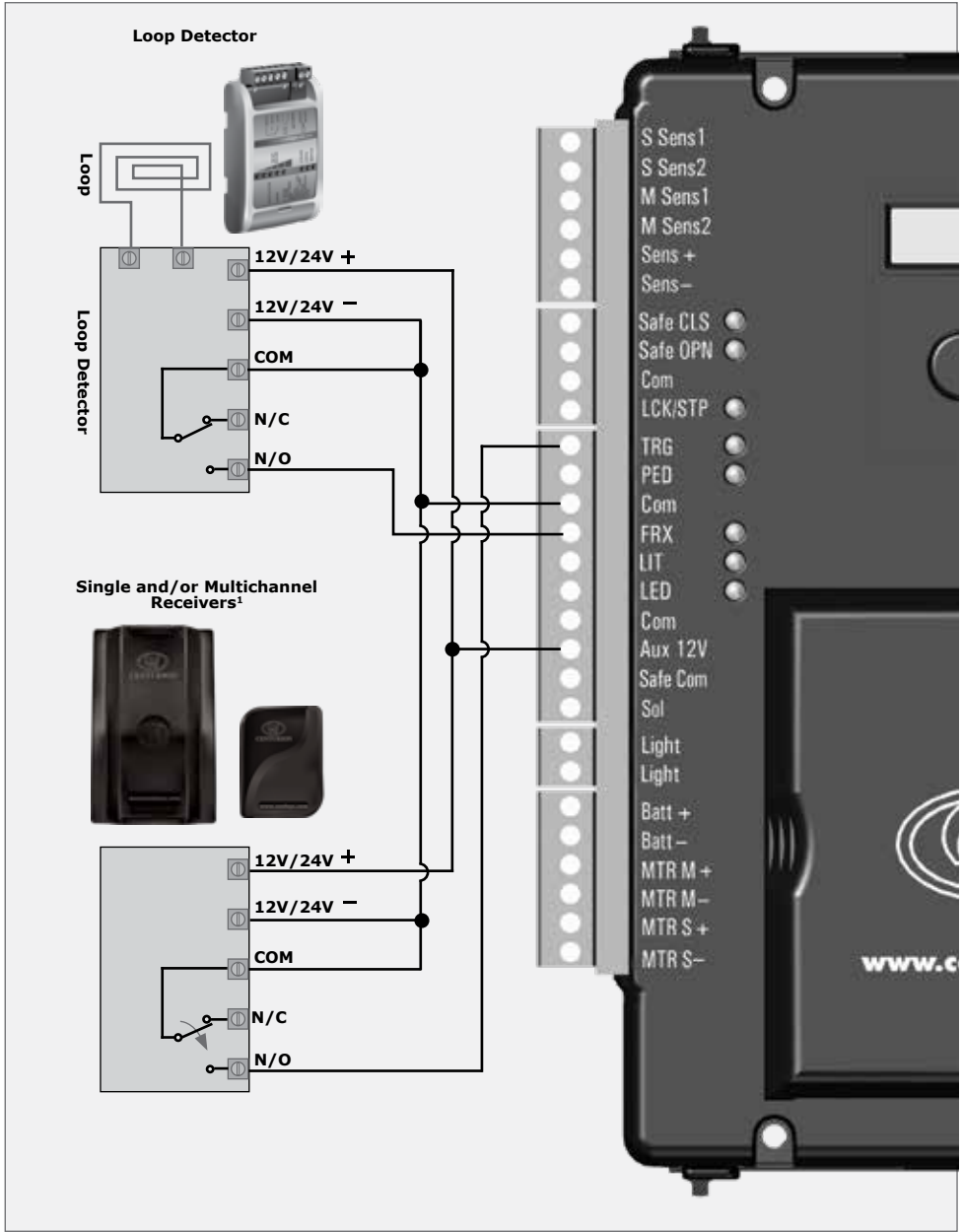

FIGURE 15. OPTIONAL RADIO RECEIVER AND LOOP DETECTOR

1. Only applicable if external radio receiver is being used

14. Electric Gate Lock/Maglock

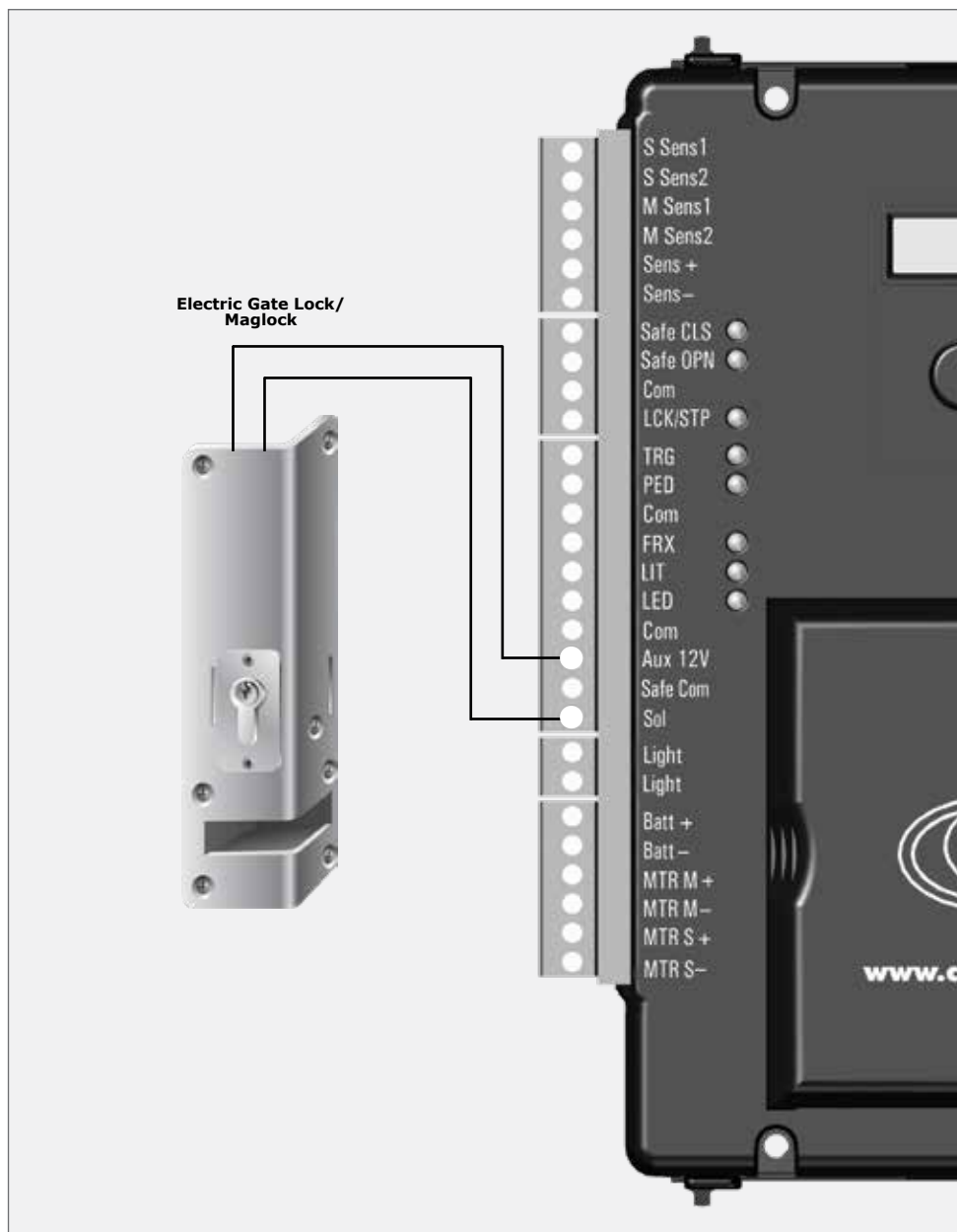
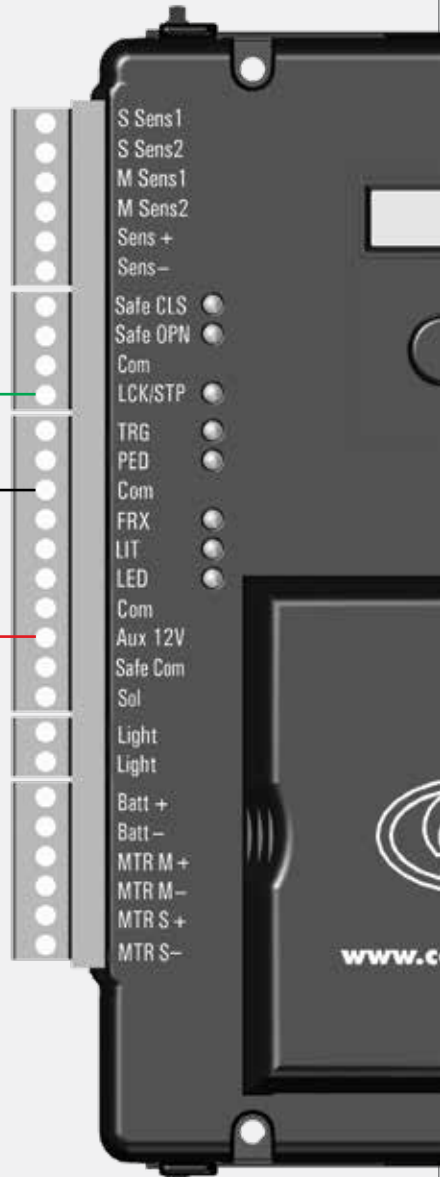
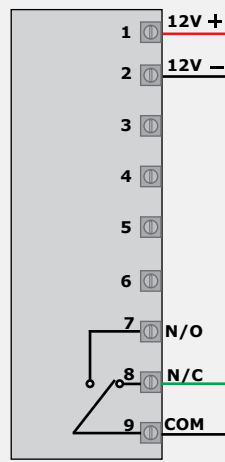

FIGURE 16. ELECTRIC GATE LOCK/MAGLOCK

15. Holiday Lockout Keyswitch/Keypad

**Holiday Lockout
Keyswitch/Keypad
(Normally-Closed)**



Main Features

- SMARTGUARD for hard-wired installations
- SMARTGUADair for wireless, easy installations
- 1000 unique codes using one to ten digits
- Selectively add and delete user codes
- Backup Memory Module
- Limited uses counter
- Fully weatherproof with backlit keypad

FIGURE 17. HOLIDAY LOCKOUT KEYSWITCH/KEYPAD NORMALLY-CLOSED

16. Pedestrian Keyswitch/Keypad

**Pedestrian
Keyswitch/Keypad
(Normally-Open)**

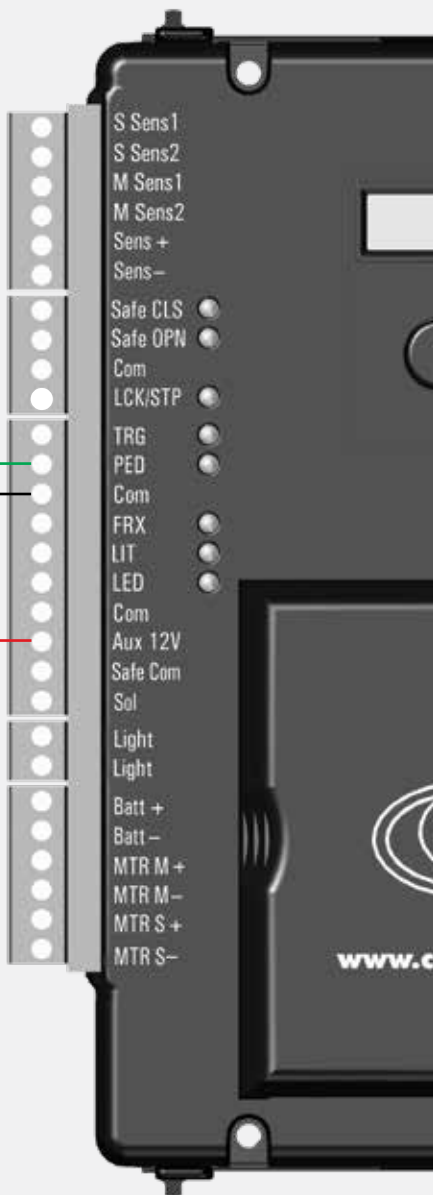
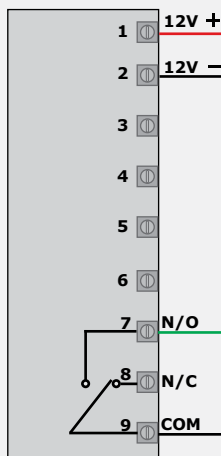

FIGURE 18. PEDESTRIAN KEYSWITCH/KEYPAD NORMALLY-OPEN

17. G-SPEAK Classic+ Intercom

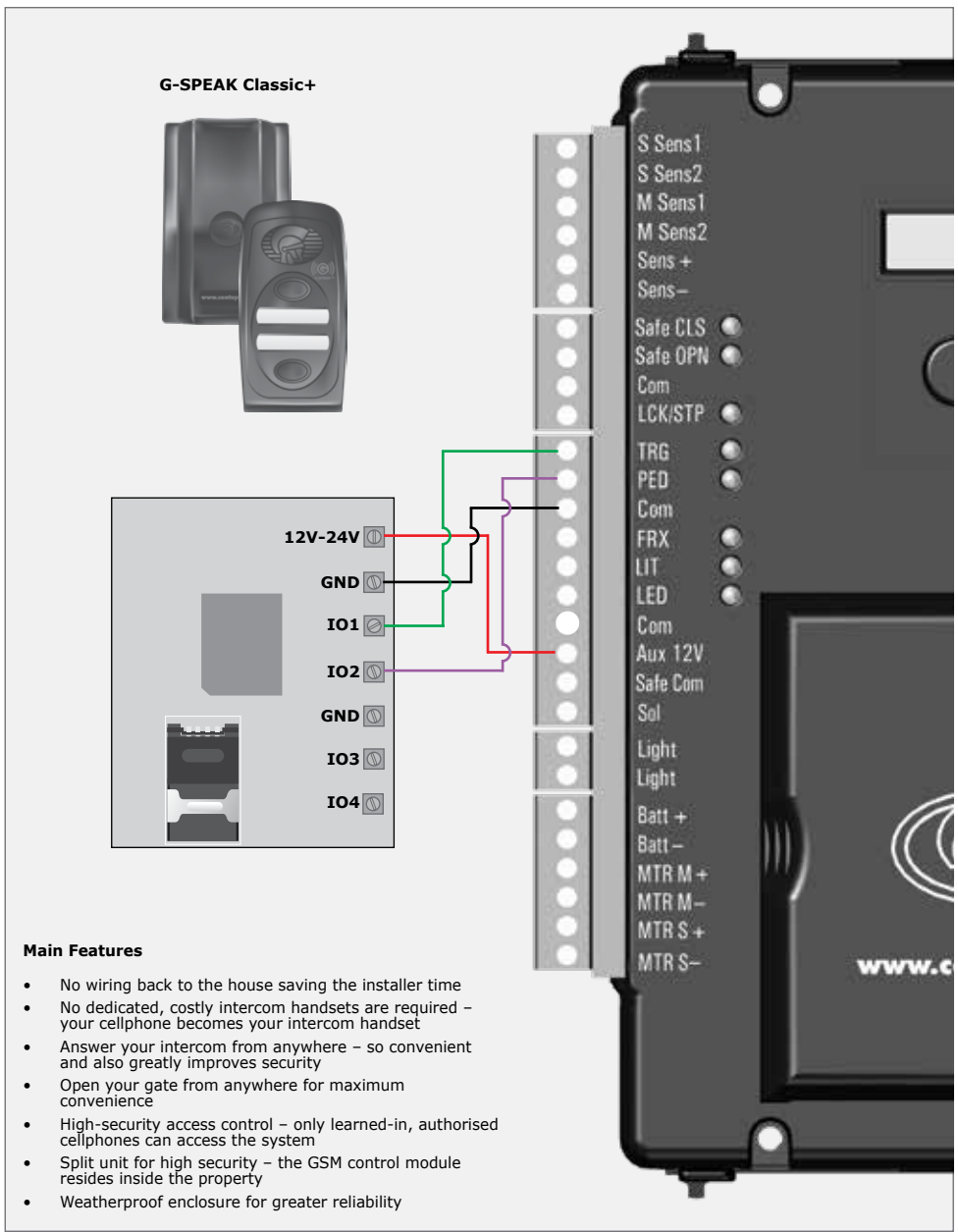

FIGURE 19. G-SPEAK CLASSIC+ INTERCOM

18. G-SWITCH-22 Monitoring & Control

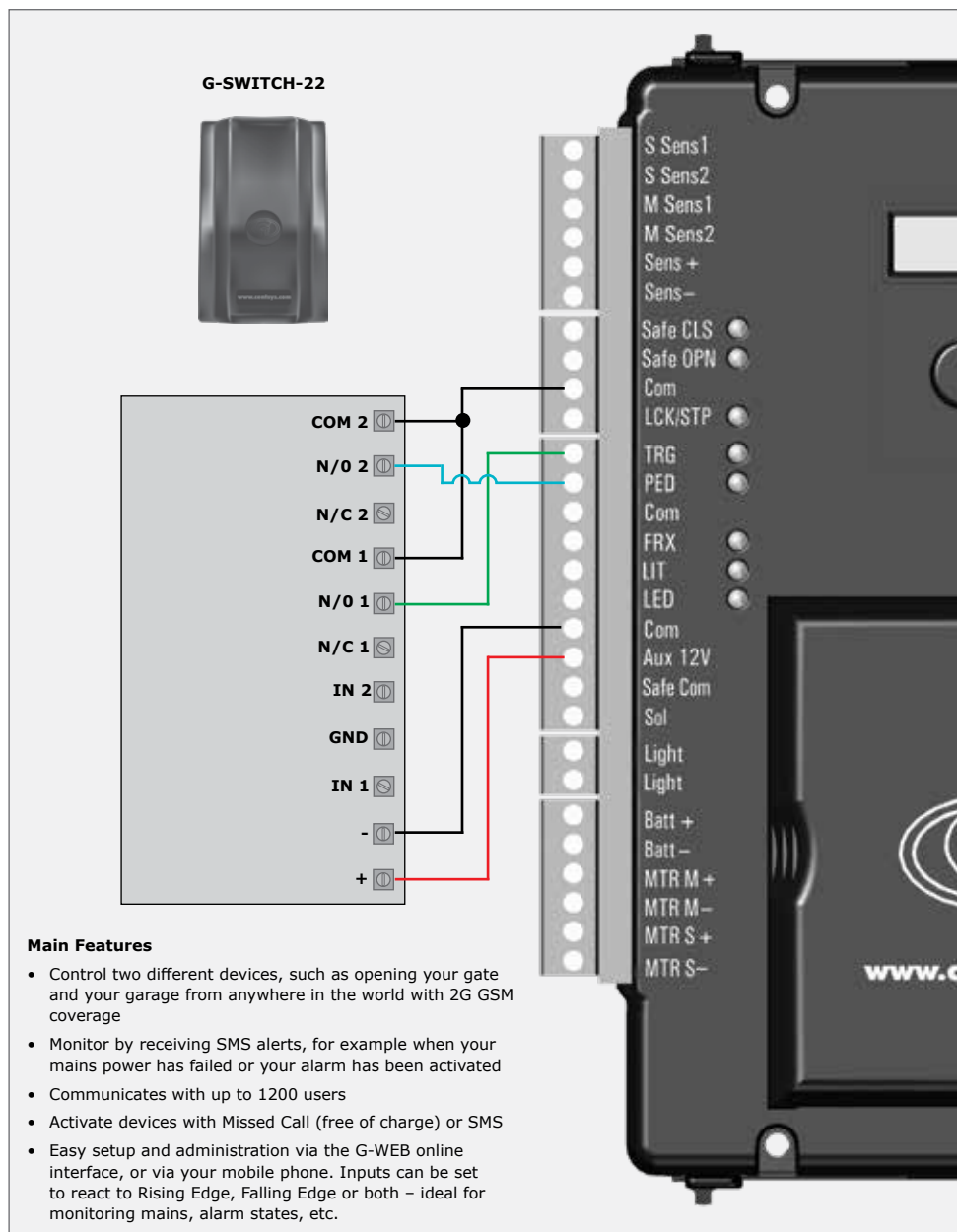
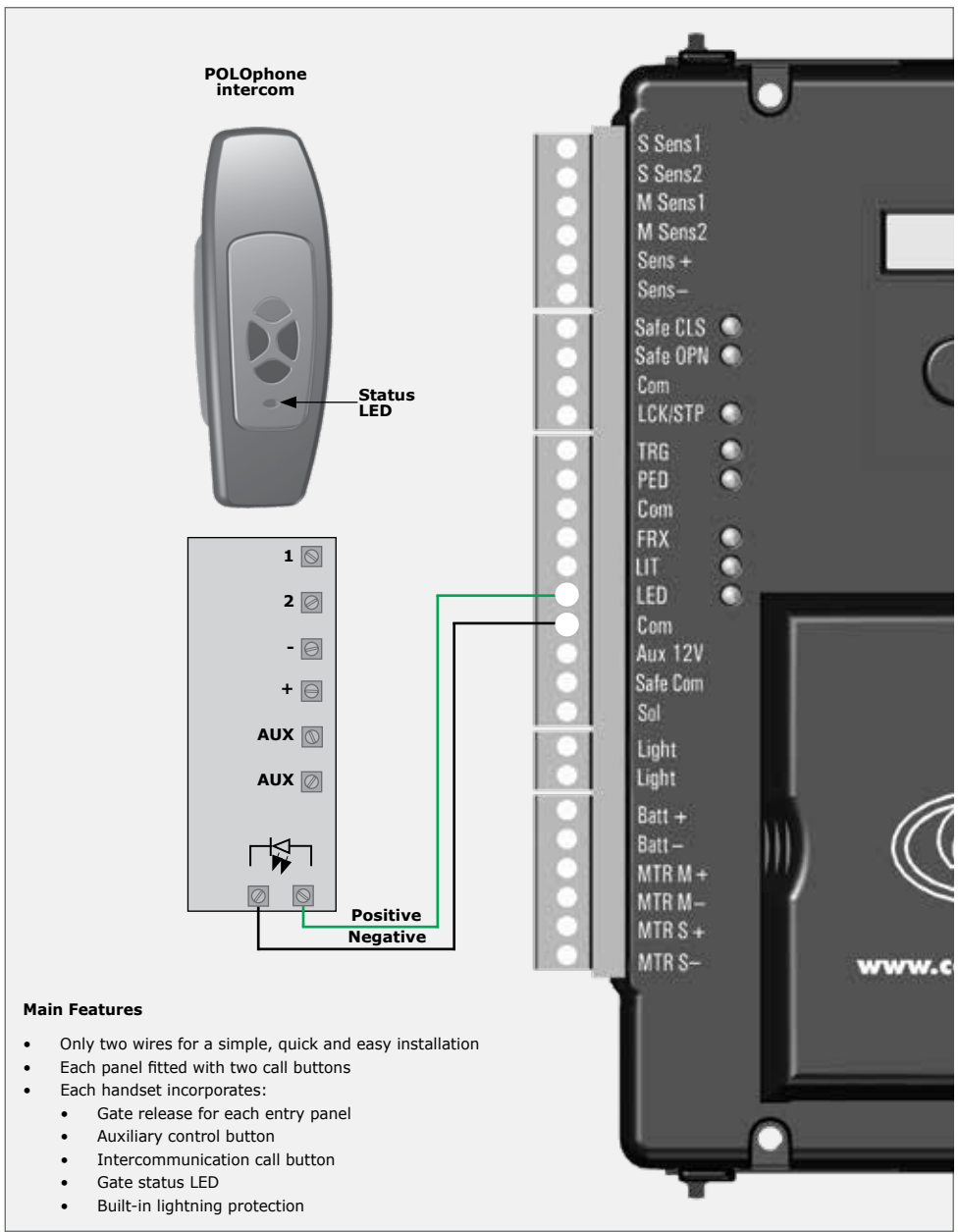

FIGURE 20. G-SWITCH-22 MONITORING & CONTROL

19. Status LED



Main Features

- Only two wires for a simple, quick and easy installation
- Each panel fitted with two call buttons
- Each handset incorporates:
 - Gate release for each entry panel
 - Auxiliary control button
 - Intercommunication call button
 - Gate status LED
 - Built-in lightning protection

FIGURE 21. STATUS LED

20. Solar Panel

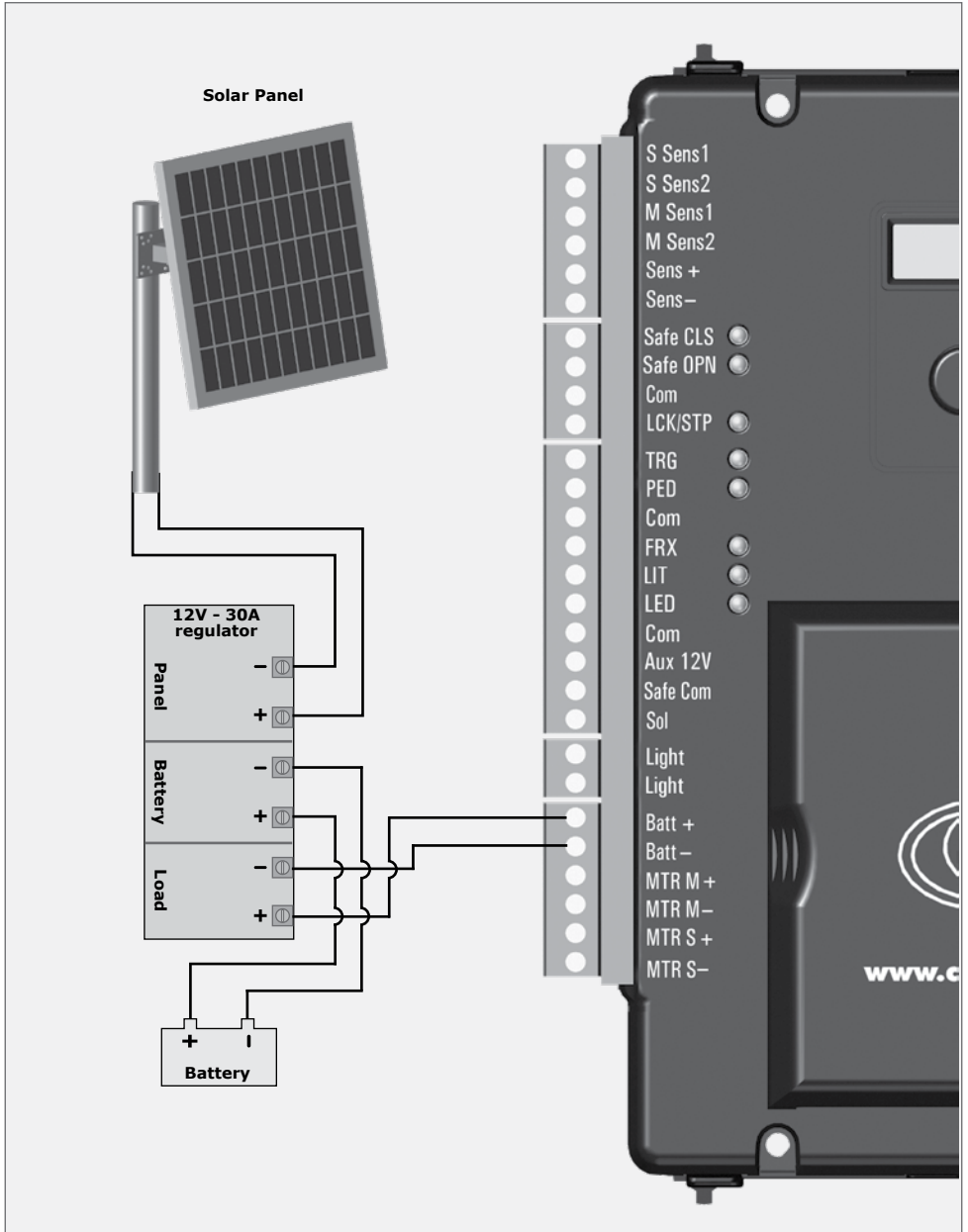

FIGURE 22. SOLAR PANEL

21. Pillar Light Push button (Normally-Open)

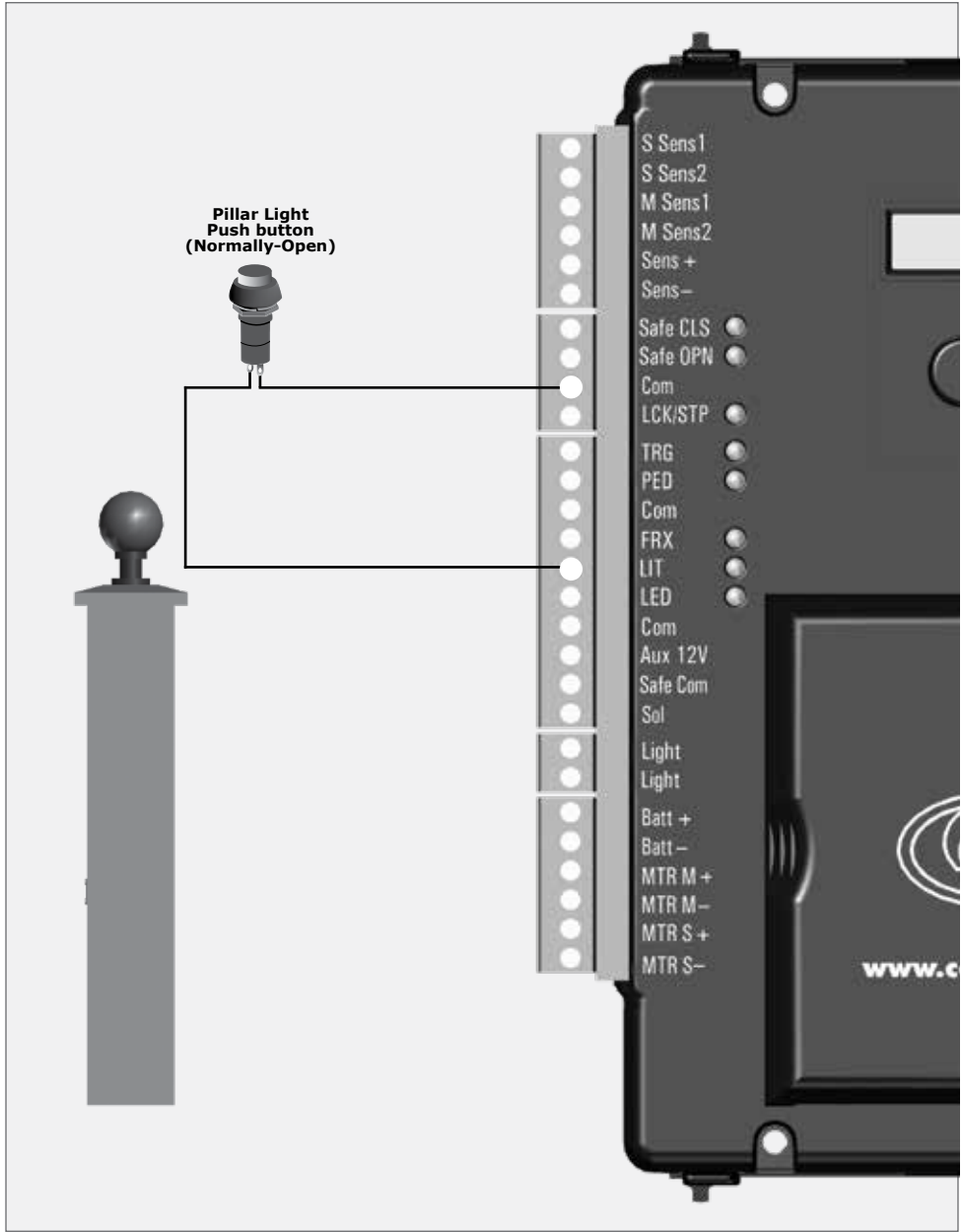

FIGURE 23. PILLAR LIGHT PUSH BUTTON (NORMALLY-OPEN)

22. Charger & Pillar Light Connections

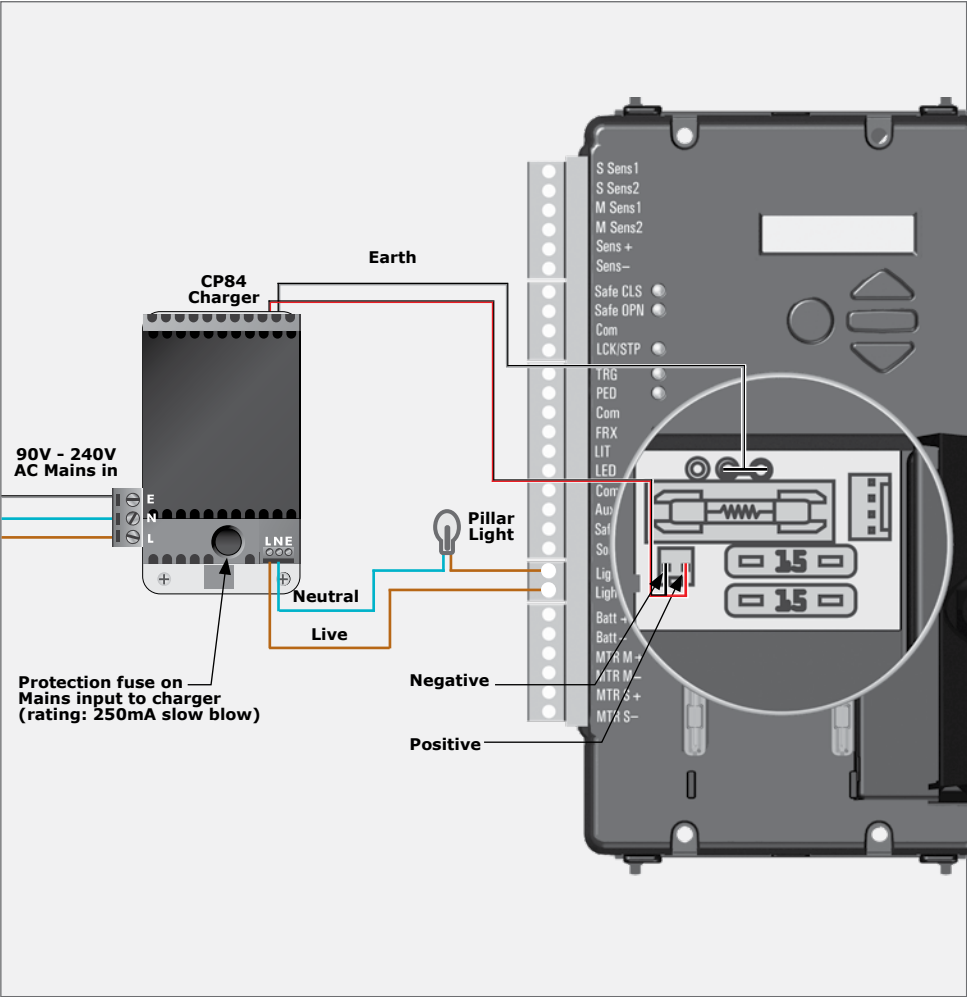

FIGURE 24. CHARGER AND PILLAR LIGHT CONNECTIONS

22.1. Fuse Protection

The following protection fuses are provided on the system:

Item	Type	Rating
Main Controller Motor Circuit - fuse per channel	Automotive Fuse (25 x 7)	15A
Light circuit	5 x 20mm	3A Fast Blow
Auxiliary supply	Electronic fuse ¹ - not replaceable	3A
Charger Mains Input	Non user replaceable fuse	250mA

TABLE 1

1. To reset: Power off Controller for at least one minute and re-apply power

23. Setting up Additional Features

The Controller Menu Structure on page 36 provides the full suite of features that can be set up on the system.

An explanation of each feature is provided in Section 25 'Controller Features' on page 40.

When setting up the system via the LCD display, all the steps that have to be followed are clearly provided via the display. It is only necessary to note the following:

1. To get into Setup Mode, press the (●) button for three seconds and follow the instructions provided from there.
2. The buttons provided on the Controller for navigating the system are not marked because at each step during the Setup, the function given to each button is provided on the display.

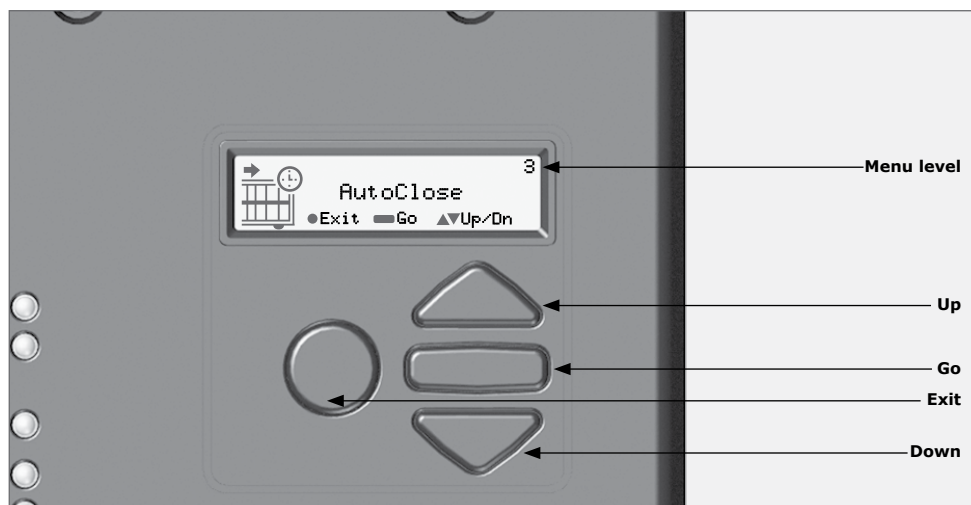

FIGURE 25. VIEW OF CONTROLLER

3. When not in Setup Mode, i.e. Normal Mode, the (●) button is used as a test button for operating the system. The up/down buttons are not used unless the diagnostic screens have been selected to appear in Normal Mode, in which case these buttons allow switching from one screen to the next.

For each feature a Factory Default setting has been programmed into the Controller. Referred to as an Operating Standard, these defaults have been determined to suit the requirements of the specific region where the installation is being carried out. It is only necessary to change a feature where the default does not suit the installation. When selecting any feature in the menu, details of the current setting stored in the Controller are displayed.

Refer to page 56 to 64 for the Factory Defaults Schedule for each feature.

24. Controller Menu Structure



1. Setting Limits



1.1. Setup wizard



2. Safety

2.1. MTR M Collision Force

- MTR M Opening Collision Force
- MTR M Closing Collision Force
- MTR S Opening Collision Force
- MTR S Closing Collision Force

2.2. MTR S Collision Force

2.3. Collision Count

2.4 Alarm Output

- LED - Status LED
- SOL - Solenoid
- SAFC - Safety Common
- LGHT - Light
- BUZZ - Onboard buzzer



3. Autoclose

3.1. Autoclose Status

3.2. Autoclose Timer

3.3. Autoclose Override

3.4. Autoclose Advanced Options

- Autoclose Fully Open
- Autoclose Partly Open
- Autoclose Partly Closed



4. Modes of Operation

4.1. Operating Mode

- Standard Mode
- Condominium Mode
- Reversing Mode



5. Run Profile

5.1. Positive Close Mode

- Positive Close Status
- Positive Close Mode Type
 - MTR M & MTR S
 - MTR S Only
 - MTR M Only

- Short Stop
 - Positive Close Short Stop Value
 - Positive Close Push Force
 - Positive Open Status
 - Positive Open Type
 - MTR M & MTR S
 - MTR S Only
 - MTR M Only
 - Positive Open Push Force
 - Leaf Delay Status
 - Leaf Delay Value
- 5.2. Positive Open Mode
- 5.3. Leaf Delay
- 5.4. Pre-open Delay
- 5.5. Pre-close Delay
- 5.6. Opening Speed
- 5.7. Closing Speed
- 5.8. Ramp-up Distance
- 5.9. Ramp-down Distance
- 5.10. Crawl Distance
- 5.11. TRG Stop Distance
- 5.12. IRB Stop Distance
- 5.13. Push Force Limit



6. Infrared Beams

- 6.1. PIRAC Control
- 6.2. IR Beam Test
- PIRAC Status
 - IR Beam Test Status
 - Beam to Test
 - IRBC Only
 - IRBO Only
 - IRBC and IRBO
- 6.3. IRBO = IRBC on Closing
- 6.4. IR Beam Alarms
- Ambush Alarm
 - Ambush Alarm Status
 - IRB Broken Time
 - Break-in Alarm
 - Break-in Alarm Status

CONTINUED OVERLEAF

- Alarm Output
 - LED
 - SOL
 - SAFC
 - LGHT
 - BUZZ



7. Pedestrian

- 7.1. Pedestrian Open Position
- 7.2. Pedestrian Autoclose Time
- 7.3. Pedestrian pre-open Delay
- 7.4. Pedestrian pre-close Delay



8. Gate Lock

- 8.1. Lock Enabled Status
- 8.2. Lock Type
 - Mag Lock
 - Strike Lock
- 8.3. Release Time
- 8.4. Pre-Release Time
- 8.5. Lock Location
 - Both (Open and Closed Position)
 - Closed Position
 - Open Position
- 8.6. Gate Lock Power Supply
 - AC
 - DC



9. Courtesy Light

- 9.1. Courtesy Light Timer
- 9.2. Light Profile
 - Courtesy Light
 - Pre-flash A
 - Pre-flash B
 - Pre-flash C



10. General settings

- 10.1. Operator
 - V400/V500
 - VERT-X
 - VECTOR

- 10.2. Operating Profile
 - ZA
 - CE
 - UL325
- 10.3. Reset Options
 - Factory Default
 - Delete All Remotes
 - Reset All
- 10.4. Diagnostic Screen
 - Turn Diagnostics On
 - Turn Diagnostics Off
- 10.5. Round test button
 - Round Test Button On
 - Round Test Button Off



11. Remote Controls



**Press button of valid remote control
(if menu locked)**

- 11.1. Add remotes
 - Courtesy Light
 - Holiday Lockout
 - Open Gate FRX
 - Pedestrian
 - Trigger Gate
- 11.2. Delete remotes
 - Delete by ID
 - Delete button
 - Delete by button
 - Delete all remotes
- 11.3. Edit remote button
- 11.4. Tx menu locked

25. Controller Features



25.1. Menu 2 - Safety (Collision Force)

25.1.1. Collision Force

If the gate is obstructed, the internal collision circuitry will activate. The response of the system to a collision will vary, depending on the profile selected (Operating Standard, eg. ZA). Responses can vary from the gate stopping, to the gate reversing. The **Collision Force** can be set from minimum to maximum in five discrete steps.

A sixth step will disable collision sensing entirely, allowing maximum force to be achieved. Under this condition, the motor will continue running until it stalls, at which point a collision will be detected.



This level should only be used if additional safety measures are taken (eg. Infrared Safety Beams, etc.).

Collision Force can be set independently per direction of travel.

25.1.2. Collision Count

A counter monitors the number of collisions that the gate experiences before it reaches the fully closed position. If the value exceeds the value set in the **Multiple Collision Counter**, the Controller shuts down until the next valid trigger is received. As an indication, the status LED will flash four times every two seconds. The **Multiple Collision** fault indication will continue to flash indefinitely or until a valid trigger has been received.



25.2. Menu 3 - Autoclose



This feature must only be used if infrared gate safety beams are installed to prevent the gate(s) from closing onto people, pets or vehicles.

25.2.1. Autoclose Status

When enabled, the **Autoclose** feature has the function of automatically closing the gate after a preset **Autoclose** time. The **Autoclose** feature is **automatically** turned on when the Controller is set for **Condominium Mode**.

25.2.2. Autoclose Timer

The **Autoclose** time can be set anywhere from 1 to 255 seconds.

25.2.3. Autoclose Override

It is possible for the user to temporarily turn off **Autoclose** when the Mode of Operation is **Standard** or **Reversing**. To activate **Autoclose Override**, the Trg input must be activated and maintained for a period longer than the time set for the **Autoclose Override Time**. For example, suppose that the Autoclose Override time is left at the default value of 3 seconds. If a remote button (learned to activate the trigger function of the onboard receiver) is pressed and held for a period exceeding 3 seconds, Autoclose will temporarily be disabled.

The gate response will be to start opening on the Trg trigger, and then to stop as soon as the **Autoclose Override** time is reached. On clearing of the Trg input, the gate will continue opening until fully open. The **Autoclose** feature is now temporarily disabled and the gate will remain open indefinitely. To disable Autoclose override, the TRG input needs to be activated again.

25.2.4. Autoclose Advanced Options

The conditions under which the gate will automatically close can be set within the **Advanced Autoclose** options menu:

- **Autoclose Fully Open** - automatically closes the gate if it has reached the fully open position
- **Autoclose Partly Open** - automatically closes the gate if it is stopped while opening, but before reaching the fully opened position
- **Autoclose Partly Closed** - automatically closes the gate if it is stopped while closing, but before reaching the fully closed position



25.3. Menu 4 - Modes of Operation

It is possible to select the following Modes of Operation: **Standard, Condominium, and Reversing Mode**. All modes are triggered by closing a normally-open contact between the Trg input terminal and the Com terminal.



The functionality described in this section can be activated using the onboard multichannel receiver.

25.3.1. Standard Mode

When stationary, a trigger impulse on Trg will cause the gate to either open or close. On a moving gate, a trigger impulse on Trg will stop the gate. The next impulse on Trg will cause the gate to reverse its direction of travel; i.e. the action is **start-stop-reverse**.

25.3.2. Condominium Mode

A trigger impulse on Trg will open the gate under all conditions. If it is closing, it will stop and reverse to open. In this Mode of Operation, the only way to close the gate is with the **Autoclose** feature, which is automatically activated when **Condominium Mode** is selected.

25.2.3. Reversing Mode

A trigger impulse on Trg will reverse the direction of a moving gate. If it is closing, it will stop and immediately begin opening. If it is opening, it will stop and immediately begin closing.



25.4. Menu 5 - Run Profile

25.4.1. Positive Close Mode (PCM)

Setting **Positive Close Mode** to ON will allow the gate to drive up hard to the closed endstop without causing the collision circuitry to operate. This is extremely useful in cases where a magnetic lock mounted on one gate leaf needs to engage with its armature plate mounted on another leaf or pillar.

This feature operates only during the last few millimetres of gate travel in Closing Mode.

25.4.2. Positive Close Type

PCM can be applied to one of the following:

- Short Stop (further explanation follows)
- Master Motor (MTR M)
- Slave Motor (MTR S)
- Both Master and Slave Motors

25.4.3. Short Stop

PCM applied to one gate is ideal for securely locking two gates to each other without having to fit endstops.

Typically, a 'mechanical' lip is fitted to one gate which will push up against the other gate and via PCM keep pushing until the gates are mechanically locked.

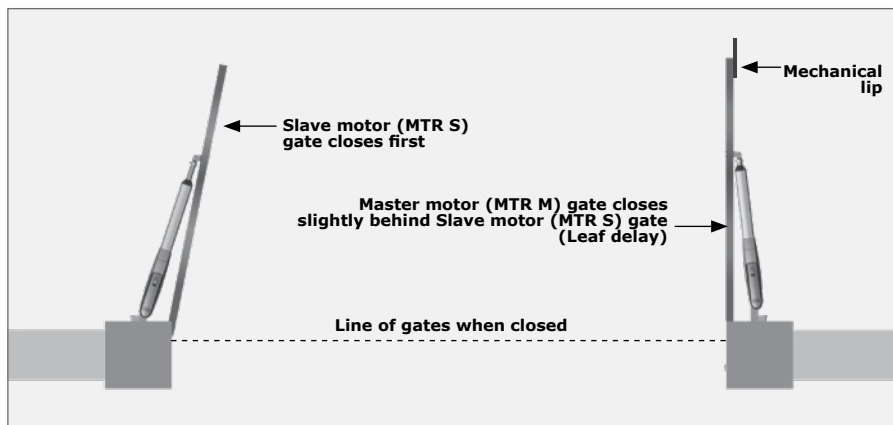

FIGURE 26

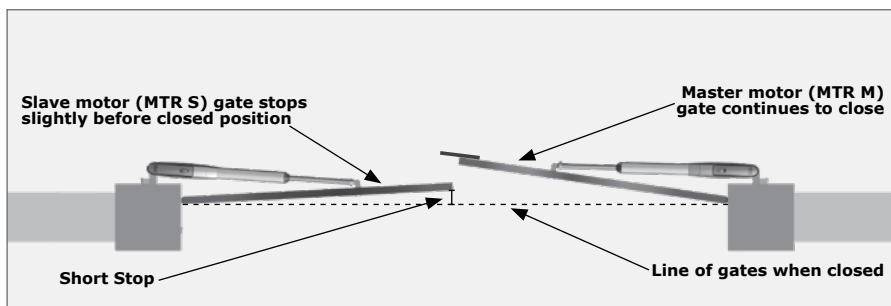

FIGURE 27

To ensure that the gates do not close past their desired end point, the Slave Gate against which the Master gate with the mechanical lip pushes, can be preset to stop slightly short of its closed position. This is referred to as the 'Short Stop' distance.

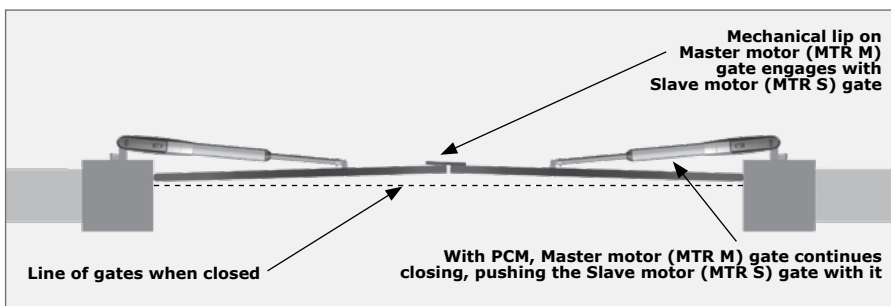

FIGURE 28

If the 'Short Stop' distance is correctly set, the Master Gate will engage with the Slave Gate sufficiently before the closed position and via the PCM, push the two gates into the fully closed position, but not past it.

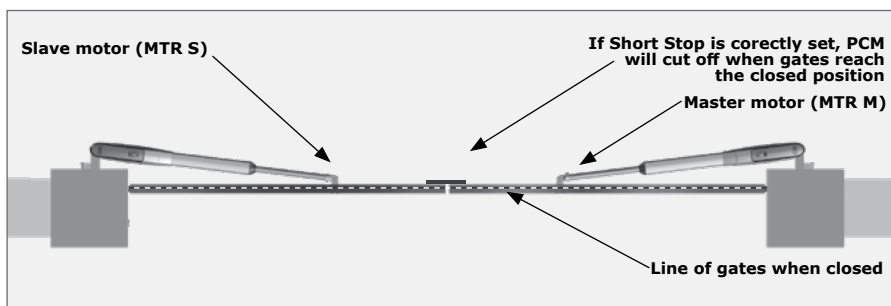

FIGURE 29

25.4.4. Short Stop value

The Short Stop distance can be set between 1mm and 20mm of piston stroke.

25.4.5. PCM push force

The amount of force applied by the operator when in PCM can be set as a value from 33% to 100% in five increments.

25.4.6. Positive Open Mode (POM)

Setting Positive Open Mode to ON will allow the gate to drive up hard to the open endstop without causing the collision circuitry to operate. This feature operates only during the last few millimetres of gate travel in Opening Mode.

25.4.7. Positive Open type

POM can be applied to one of the following:

- Master Motor (MTR M)
- Slave Motor (MTR S)
- Both Master and Slave Operators

25.4.8. POM Push Force

The amount of force applied by the operator when in POM can be set as a value from 33% to 100% in five increments.

25.4.9. Leaf Delay

Leaf Delay is used in cases where one gate leaf must move before the other. The most common need for this arises when a mechanical 'lip' is fitted to one of the gates.

In a double leaf installation, a Leaf Delay can be set whereby the MTR S Motor will close before the MTR M Motor.

25.4.10. Leaf Delay value

The Leaf Delay is based on piston position, and can be adjusted from 1mm to 250mm of piston travel.

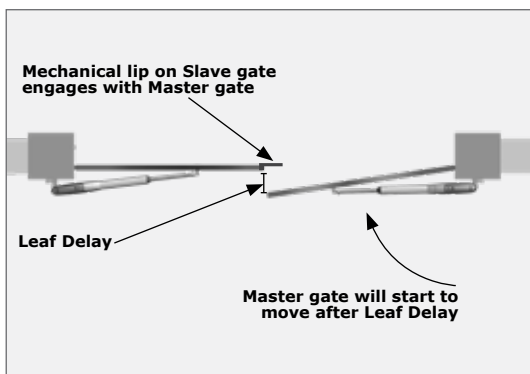

FIGURE 30

25.4.11. Pre-open Delay

Allows a delay between a valid trigger signal being received and the gate commencing movement in the opening direction. A Warning Light can be set to activate during this delay. (Refer to Pre-flash Modes of the feature 'Pillar Light', for more details.) This setting applies to both operators.

A Pre-open Delay is typically used to allow a pedestrian sufficient time to move clear of the gate area prior to the gate commencing movement, or for a warning beacon to be activated.

25.4.12. Pre-close Delay

Allows a delay between a valid trigger signal being received and the gate commencing movement in the closing direction. The delay will also occur if the gate is set to close automatically. A Warning Light can be set to activate during this delay.

A Pre-close Delay is typically used to allow a pedestrian sufficient time to move clear of the gate area prior to the gate commencing movement, or for a warning beacon to be activated.

(Refer to Pre-flash Modes of the feature 'Pillar Light', for more details). This setting applies to both operators.

25.4.13. Opening Speed

Sets the maximum piston opening speed in millimeters per second. This setting applies to both operators.

25.4.14. Closing Speed

Sets the maximum piston closing speed in millimeters per second. This setting applies to both operators.

25.4.15. Ramp-up Distance

Sets the Ramp-up Distance in millimeters of travel of the piston when starting. This feature is used to allow for smooth and fluid gate movement during opening. This setting applies to both operators

25.4.16. Ramp-down Distance

Sets the Ramp-down Distance in millimeters of travel of the piston when stopping. This setting applies to both operators. This feature is used to allow for a smooth deceleration of the gate to prevent the gate from stopping abruptly and placing undue stress on the installation.

25.4.17. Crawl Distance

Sets the final Crawl Distance in millimeters of travel of the piston when reaching an endpoint. This setting applies to both operators.

25.4.18. Trigger Stop Distance

The distance the piston travels before stopping on a trigger input. This feature is used to relieve the strain placed on the mechanical components by stopping the gate smoothly when a trigger signal is received.

25.4.19. Beam Stop Distance

The distance the piston travels before stopping on a beam input. This value is normally set to stop the gate as quickly as possible so as to prevent injury to persons; it is recommended that the value be selected so as to prevent undue stress on the installation.

25.4.20. Push Force Limit

Sets the maximum push force delivered by the operators. The maximum setting is a value of 15 and the minimum is five. This is useful in cases where limited push force is required. This setting applies to both operators.

I5 25.5. Menu 6 - IR beams

In a swing gate installation, in order to provide protection to a person or vehicle moving through the entrance, it is necessary to have two sets of **Safety Beams**, one across the driveway where the gates are closed and another where the gates are open. Both sets of **Safety Beams** must be set as **Closing Safety Beams**, preventing the gate from closing and stopping the gates if they have started to close if the beams are obstructed.

However, across the line of the driveway up to where the gates open, it is also recommended to have another set of **Opening Safety Beams** to prevent the gate from opening if they are closed and stop if they are opening if the beams are obstructed.

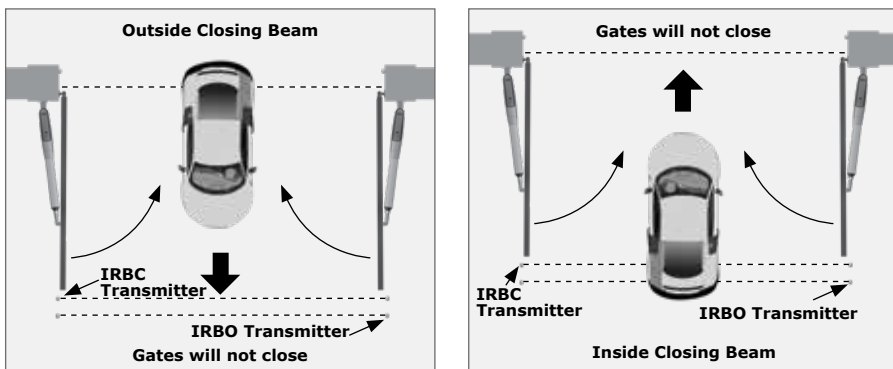

FIGURE 31

Two independent normally-closed inputs are provided for Opening and Closing **Safety Beams**.



It is recommended that additional Opening Beams are fitted to reduce the risk of a person or pet being crushed between the opening gate and the wall.

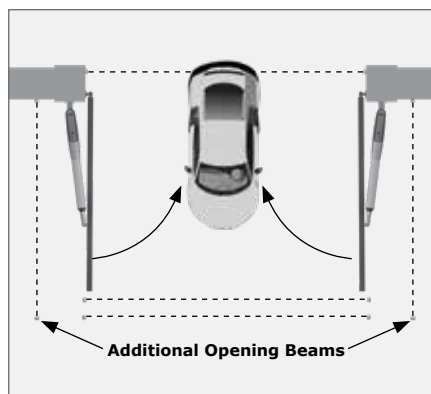

FIGURE 32

Additional beam functionality:

25.5.1. PIRAC Control

The **Passive-Infrared Autoclose** feature allows the gate to close automatically, as soon as a vehicle or pedestrian has passed through the Closing Beam.

This security feature ensures that the gate stays open for the minimum amount of time possible. If the **PIRAC** feature has been enabled, the system will react in the following way:

- When the gate is triggered to open and nothing moves through or interrupts the Closing Beam, the gate will open fully and stay open for the period of time determined by the **Autoclose Timer**
- However, if the Closing Beam is interrupted at any stage, while the gate is opening or open, the gate will close immediately after the Closing Beam is cleared



If the Autoclose feature has not been enabled then the gate will remain open indefinitely. To close the gate the Closing Beam must be interrupted or the trigger button must be pressed.

25.5.2. IR Beam Test (only compatible with i5 Safety Beams; not compatible with Photon wireless Safety Beams).

Automatically tests the Safety Beams before each gate cycle. (eg. as required by CE.) In order for this feature to work, the power supply negative of the beam transmitter must be wired to the Safe Com terminal of the Controller.

25.5.3. IRBO=IRBC

Configures the Opening Beam to act as a Closing Beam while the gates are closing. This allows one set of Safety Beams to be used across the line of the driveway up to where the gates open.

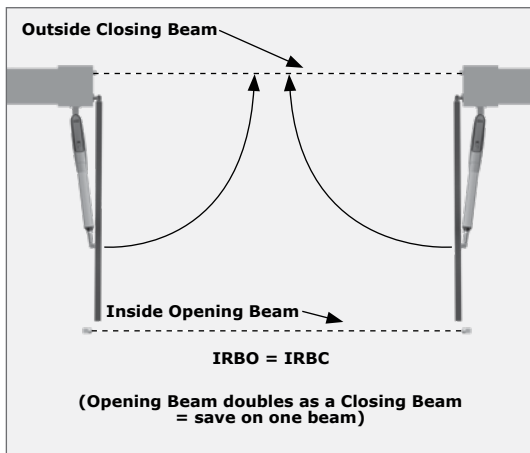

FIGURE 33



If the Opening Safety Beam is interrupted the gate will stop; it will neither open nor close due to the Opening Safety Beam acting as both an Opening and Closing Beam.

25.5.4. IR Beam Alarms

While the gate is fully closed, this feature allows the following alarms:

25.5.4.1. Ambush Alarm

Activates an alarm if either the Opening or Closing Beams have been continuously interrupted for a pre-defined time. The alarm will remain activated while the beams are interrupted.

For example, if a would-be intruder covers the **Safety Beams** so that when the gate is opened, the gate will stay open, the system will detect this beam override taking place and set off an alarm.

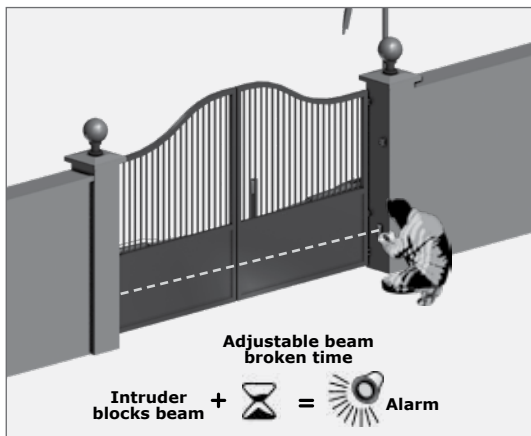

FIGURE 34

25.5.4.2. IR Beam Broken Time

The time that the Beams must be interrupted before the ambush alarm is activated.

25.5.4.3. Break-in Alarm

Activates an alarm if the Closing Beam on the outside of the property is interrupted while the gates are closed. The alarm remains activated while the Beams are broken, and for a fixed period of 30 seconds thereafter.

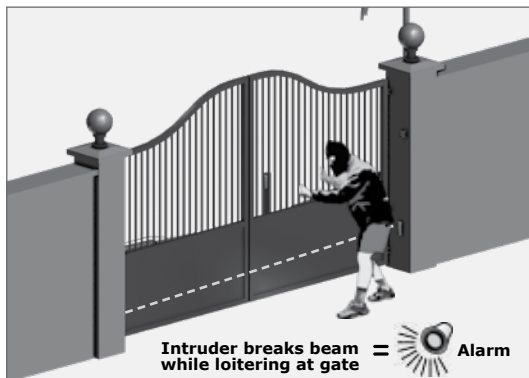

FIGURE 35



If this break-in alarm is used, it is recommended that TWO parallel Closing Beams be used to reduce the chance of false triggering.

25.5.4.4. Alarm output

The system can be configured to operate one of the following outputs provided on the Controller:

- **Status LED output** (operate up to three LEDs in parallel or interface with the CP78 MULTI-LED driver card)
- **Sol** (this is an open collector drive, maximum current draw 3A, not fuse-protected)
- **Safe Com** (this is an open collector drive, maximum current draw 3A, not fuse-protected)
- **Pillar / Courtesy Light contact** (potential-free normally-open contact, fuse-protected - 5A)
- **Onboard buzzer** - emits a continuous tone



24.6. Menu 7 - Pedestrian Opening

This feature is associated with the PED input on the Controller, and can be activated using the onboard multichannel receiver. When activating this input, the system will open the gate to the Pedestrian Open position, and then automatically close after the **Pedestrian Autoclose** time lapses. If the **PED** connection to Com is maintained, then the gate will remain open, and when the connection is broken, it will close after the **Pedestrian Autoclose** time has expired.

The time taken for the gate to open to pedestrian is dependent on the pedestrian **Pre-open Delay** and the time required for the gate to close from the pedestrian position is dependent on the **Pedestrian Pre-close Delay**.

25.6.1. Pedestrian Open Position

Sets the maximum opening of the pedestrian gate as a percentage of total travel.

25.6.2. Pedestrian Autoclose Time

Sets the Autoclose time in seconds after the gate has reached the Pedestrian Open Position. This time can be set from zero seconds to four minutes in one second increments.

25.6.3. Pedestrian Pre-open Delay

Sets the time delay between the Pedestrian Opening input being activated and the gate commencing movement. This enhances safety in cases where the pedestrian has to reach through the gate in order to activate the pedestrian input. This delay can be set from zero seconds to four minutes in one second increments.



A **Warning Light** would typically be active during this delay.

25.6.4. Pedestrian Pre-close Delay

Sets the time delay between the **Pedestrian Autoclose** timer expiring, and the gate actually closing. This delay can be set from zero seconds to four minutes in one second increments.



- A **Warning Light** would typically be active during this delay
- The **Warning Light** is any light wired to the **Pillar Light** contacts, as described in Menu 9



25.7. Menu 8 - Gate Lock

A solenoid strike lock or magnetic lock can be connected to the control card, allowing the gate to be locked when closed, open or both.

25.7.1. Lock Enable Status

Turns the lock functionality ON or OFF.

25.7.2. Lock Type

Allows selection of either a solenoid strike lock, or a magnetic lock.

A solenoid strike unlocks when power is applied, while a magnetic lock unlocks when power is removed.

25.7.3. Release time

Sets the Time-period (in seconds) for which the lock remains released after the gate has started moving:

25.7.3.1. Pre-Release Time:

- Sets the Time-period (in 0.1 second increments) for which the lock releases BEFORE the gate has started moving. This is useful in cases where premature gate movement prevents the lock from releasing

25.7.3.2. Lock location:

- Specifies whether the gate is locked while closed, open or both

25.7.3.2. Lock drive:

- Specifies whether the lock is to be powered by an AC or DC voltage supply
- Selecting AC will power the lock with a 50Hz square wave



25.8. Menu 9 - Courtesy/Pillar Light

This feature is associated with the **Light** connections on the Controller. Refer to page 33 of the manual for details on how to connect a Pillar or security light to the Controller.

The Pillar Light circuit has multiple functions:

- It operates as a **Courtesy Light** and switches on for a selectable time-period every time the gate is activated
- The **Courtesy Light** can also be turned on for the same time-period by momentarily connecting the LIT terminal to the Com terminal via a pushbutton
- The **Courtesy Light** can also be turned on permanently by connecting the LIT terminal to the Com terminal via a pushbutton, for three seconds. A short pulse thereafter will switch the lights off. The status LED will flash once every two seconds to indicate that the Courtesy Light is on permanently. The abovementioned facility can also be achieved via a remote learned to the system and mapped to the **Courtesy Light** function from within the remotes menu



The gate will not open when using the **LIT** input.

- When the **PED** input is triggered, the **Courtesy Light** flashes for an adjustable pre-flash time (0 to 255 seconds), before the pedestrian gate opens.

25.8.1. Courtesy Light Time

The time for which the Courtesy Light will remain activated can be set from four seconds to ten hours in one second increments.

25.8.2. Light Profile

The Courtesy Light can be selected to operate according to one of the following:

- Courtesy Light as explained earlier
- Pre-flashing Mode
- If Pre-flashing Mode A, B or C is selected, the behaviour of the Courtesy Light will be as follows:
 - Mode A will **turn on** the Courtesy Light only while the gate is moving
 - Mode B will **flash** the Courtesy Light during the Pre-opening and Pre-closing Delays, as well as while the gate is moving
 - Mode C will **turn on** the Courtesy Light during the Pre-opening and Pre-closing Delays, as well as while the gate is moving
 - In these Pre-flashing Modes, the timed Courtesy Light functionality is not available



25.9. Menu 10 - General Features

25.9.1. Operator

This menu item allows the user to set the type of **V-Series** operator currently being used with the Controller. Always ensure that the correct operator is selected. When not in Setup Mode, i.e. Normal Mode, the currently-enabled operator will be displayed in the bottom left-hand corner of the LCD screen; 'VN' refers to **V400/V500**, 'VX' refers to **VERT-X**, 'VC' refers to **VECTOR2**.

25.9.2. Operating Standard

Regional Operating Standards can be set. Applying this setting will automatically configure the Controller settings to conform to the specific region's standard. Refer to Section 26 (eg. UL325, CE or ZA.)

25.9.3. Reset Options

The Controller settings can be reset through the **Reset Options** menu. Various reset options are available:

- **Factory Defaults** - All settings will be restored to the default values dictated by the Operating Standard/Profile that is currently selected.
Remote controls and gate limits will not be affected
- **Delete All Remotes** - Delete all the remotes stored in the system.
No settings affected
- **Reset All** - Clears and defaults the system completely. The unit will be reset to the **Factory Default** settings in addition to clearing **all remotes** and **Limits**

25.9.4. Diagnostic Screen

Allows a diagnostic screen to be displayed. This can be useful when troubleshooting, but requires some technical knowledge.

25.9.5. Round Test Button

Allows the round test button on the Controller to be disabled, in cases where higher security is required.



25.10. Menu 11 - Remote Controls

The Controller is capable of learning up to **64 code-hopping remote control buttons**. Each remote control learned into the system is assigned a unique remote control ID. The system will accept one-, two- or four-button remote controls.

Benefits of the Shift Button system:



- It is possible to artificially increase the number of buttons of a multi-button remote control by using a two-button combination
- One of the buttons is used as a **Shift Button** to allow the other buttons to be used again in combination with this button. In other words, the user will press and hold the **Shift Button**, before pressing one of the other buttons to create a **new** button
- The **Shift Button** cannot be used as a button on its own, it must always be used in combination with the other buttons

25.10.1. Press Valid Button

If the **Remote Controls Menu** has been locked as discussed later, only by pressing a button of a remote control learned into the system, can the Remote Controls Menu be accessed.

25.10.2. Add Remote

Any button can be set to control the **Trigger, Pedestrian, Free-exit, Holiday Lockout** or **Courtesy Light Control (LIT)** actions. When adding remote controls, it is recommended that a record be kept of the ID number allocated by the system to each respective remote control and the person to whom the remote control is given. This is necessary should selective deletion of the remote be required at a later stage.

25.10.3. Delete Remote

Remote controls can be deleted at any stage according to one of the following methods:

- **Delete Remote by ID**
Each remote control can be deleted individually according to its unique ID. To facilitate this, a record of the ID and the person to whom the ID has been assigned must have been made at the time of learning the remote control into the system. **The remote control is not required for this operation**
- **Delete Remote Button**
The operation of a button of a particular remote control can be deleted. For example, it allows the Holiday Lockout function set on one remote button of a remote control to be cleared, without affecting the other operations that the same remote control performs. **The remote control is required for this operation**

- **Delete Remote by Button**

Use this procedure to remove the remote control from the system.

All button functionality will be removed. **The remote control is required for this operation**

- **Delete All Remotes**

Clears the entire memory. All remote controls will be erased

25.10.4. Edit Remote Button

Change the function on one remote button to perform another function.

For example, button one's function is to open the gate completely. To change this to PED, select the edit Remote Button menu, use edit Remote Button, select PED, button one of the same remote will now only open the gate to the pedestrian setting. This function can also be used to change the button functionality from 'pulse/momentary' to 'latched'.

25.10.5. Remote Control Menu locked

Allows the Remote Controls Menu to be locked, preventing the unauthorised addition of new remote controls to the system. Once enabled, the Remote Controls Menu can only be accessed by pressing a valid remote control button.

26. Factory Defaults Schedule

26.1. South African Standard Profile - ZA

Parameter Description	Unit	Minimum	Default	Maximum
Autoclose Status	On/Off		Off	
Autoclose from Fully Open	On/Off		On	
Autoclose from Partly Open	On/Off		On	
Autoclose from Partly Closed	On/Off		Off	
Autoclose Time	min:sec	00:00	0:15	04:00
Autoclose Override Time	Seconds	2	3	15
Mode of Operation	STD, REV, CON ¹		Standard	
Motor M Opening Force	Level	1	3	Max (6)
Motor M Closing Force	Level	1	3	Max (6)
Motor S Opening Force	Level	1	3	Max (6)
Motor S Closing Force	Level	1	3	Max (6)
Maximum Collisions	Collisions	1	4	255
Collision Alarm Output	Buzzer, Light, Safe Com, Sol , LED		Buzzer	
PCM ² Status	On/Off		Off	
PCM ² Type	Master, Slave, Master & Slave, Short Stop		Master Only	
PCM ² Short Stop Distance	mm of piston stroke	1	5	20
PCM ² Force	%(A)	33 (2A)	50 (3A)	100 (6A)
POM ³ Status	On/Off		Off	
POM ³ Type	Master, Slave, Master & Slave		Master Only	
POM ³ Force	%(A)	33 (2A)	50 (3A)	100 (6A)
Leaf Delay Status	On/Off		Off	
Leaf Delay	mm of piston stroke	1	10	250
Opening Speed	mm/sec	10	32	Max

TABLE 2

1. STD, REV, CON (Modes of Operation) - Standard, Reversing, Condominium
2. PCM - Positive Close Mode
3. POM - Positive Open Mode

26.1. South African Standard Profile - ZA (continued)

Parameter Description	Unit	Minimum	Default	Maximum
Closing Speed	mm/sec	10	32	Max
Ramp-up Distance	mm of piston stroke	20	30	100
Ramp-down Distance	mm of piston stroke	30	50	100
Crawl Distance	mm of piston stroke	5	5	100
Push Force Limit	Amps	5	15	15
Pre-Open Delay Time	min:sec	00:00	00:00	03:16
Pre-Close Delay Time	min:sec	00:00	00:00	03:16
TRG Stop Distance	mm of piston stroke	10	20	100
IRB Stop Distance	mm of piston stroke	10	20	100
PED Open Distance	% of piston stroke	10	30	100
PED Autoclose Time	min:sec	00:00	00:05	04:00
PED Pre-Open Delay Time	min:sec	00:00	00:02	04:00
PED Pre-Close Delay Time	min:sec	00:00	00:00	04:00
Gate Lock Enabled	Yes/No		No	
Gate Lock Type	Magnetic/Striker		Striker	
Gate Lock Pre-Release Time	Seconds	0.0	0.0	24.0
Gate Lock Release Time	Seconds	0.1	1.0	24.0
Gate Lock Location	CLS, OPN, BTH ⁴		Close Only	
Gate Lock Drive Type	AC, DC		AC	
Courtesy Light Time	h:mm:ss	0:00:04	0:02:00	9:59:59
Courtesy Light Profile	CUR, PFA, PFB, PFC ⁵		Courtesy	

TABLE 2. CONTINUED

4. CLS, OPN, BTH - Closed Position, Open Position, Both (Open & Closed Positions)

5. CUR, PFA, PFB, PFC - Courtesy, Profile A, Profile B, Profile C

26.1. South African Standard Profile - ZA

Parameter Description	Unit	Minimum	Default	Maximum
PIRAC Enabled	On/Off		Off	
IR Beam Test Enabled	On/Off		Off	
IR Beam Test	IRBC, IRBO, IRBO & IRBC ⁶		IRBC Only	
IRBO acts as IRBC	On/Off		Off	
IRB Ambush Alarm	On/Off		Off	
IRB Ambush Alarm Hold-Off Time	h:mm:ss	0:01:00	0:01:00	4:00:00
IRB Break-In Alarm	On/Off		Off	
IRB Alarms Output	Buzz, Light, Safe Com, Sol, LED		Buzzer	
Diagnostic Screen Enabled	On/Off		Off	
Test Pushbutton Enabled	On/Off		Off	
Remote Menu Locked	Yes/No		No	
Operator Selection	VC, VX, VN ⁷		VN	

TABLE 2. CONTINUED

6. IRBC, IRBO - Closing Infrared Beam, Opening Infrared Beam

7. VC, VX, VN - VECTOR2, VERT-X, V400/V500

26.2. CE Standard Profile (continued)

Parameter Description	Unit	Minimum	Default	Maximum
Autoclose Status	On/Off		Off	
Autoclose from Fully Open	On/Off		On	
Autoclose from Partly Open	On/Off		On	
Autoclose from Partly Closed	On/Off		Off	
Autoclose Time	min:sec	00:00	0:15	04:00
Autoclose Override Time	Seconds	2	3	15
Mode of Operation	STD, REV, CON ¹		Standard	
Motor M Opening Force	Level	1	3	Max (6)
Motor M Closing Force	Level	1	3	Max (6)
Motor S Opening Force	Level	1	3	Max (6)
Motor S Closing Force	Level	1	3	Max (6)
Maximum Collisions	Collisions	1	4	255
Collision Alarm Output	Buzz, Light, Safe Com, Sol, LED		Buzzer	
PCM ² Status	On/Off		Off	
PCM ² Type	Master, Slave, Master & Slave, Short Stop		Master Only	
PCM ² Short Stop Distance	mm of piston stroke	1	5	20
PCM ² Force	%(A)	33 (2A)	50 (3A)	100 (6A)
POM ³ Status	On/Off		Off	
POM ³ Type	Master, Slave, Master & Slave		Master Only	
POM ³ Force	%(A)	33 (2A)	50 (3A)	100 (6A)
Leaf Delay Status	On/Off		Off	
Leaf Delay	mm of piston stroke	1	10	250
Opening Speed	mm/sec	10	24	33

TABLE 3

1. STD, REV, CON (Modes of Operation) - Standard, Reversing, Condominium
2. PCM - Positive Close Mode
3. POM - Positive Open Mode

26.2. CE Standard Profile

Parameter Description	Unit	Minimum	Default	Maximum
Closing Speed	mm/sec	10	24	33
Ramp-up Distance	mm of piston stroke	20	30	100
Ramp-down Distance	mm of piston stroke	30	50	100
Crawl Distance	mm of piston stroke	5	5	100
Push Force Limit	Amps	5	15	15
Pre-Open Delay Time	min:sec	00:00	00:00	03:16
Pre-Close Delay Time	min:sec	00:00	00:00	03:16
TRG Stop Distance	mm of piston stroke	20	20	100
IRB Stop Distance	mm of piston stroke	20	20	100
PED Open Distance	% of piston stroke	10	30	100
PED Autoclose Time	min:sec	00:00	00:05	04:00
PED Pre-Open Delay Time	min:sec	00:00	00:02	04:00
PED Pre-Close Delay Time	min:sec	00:00	00:00	04:00
Gate Lock Enabled	Yes/No		No	
Gate Lock Type	Magnetic/Striker		Striker	
Gate Lock Pre-Release Time	Seconds	0.0	0.0	24.0
Gate Lock Release Time	Seconds	0.1	1.0	24.0
Gate Lock Location	CLS, OPN, BTH ⁴		Close Only	
Gate Lock Drive Type	AC, DC		AC	
Courtesy Light Time	h:mm:ss	0:00:04	0:02:00	9:59:59
Courtesy Light Profile	CUR, PFA, PFB, PFC ⁵		PFA	

TABLE 3. CONTINUED

4. CLS, OPN, BTH - Closed Position, Open Position, Both (Open & Closed Positions)
 5. CUR, PFA, PFB, PFC - Courtesy, Profile A, Profile B, Profile C

26.2. CE Standard Profile (continued)

Parameter Description	Unit	Minimum	Default	Maximum
PIRAC Enabled	On/Off		Off	
IR Beam Test Enabled	On/Off		On	
IR Beam Test	IRBC, IRBO, IRBO & IRBC ⁶		IRBC Only	
IRBO acts as IRBC	On/Off		Off	
IRB Ambush Alarm	On/Off		Off	
IRB Ambush Alarm Hold-Off Time	h:mm:ss	0:01:00	0:01:00	4:00:00
IRB Break-In Alarm	On/Off		Off	
IRB Alarms Output	Buzz, Light, Safe Com, Sol, LED		Buzzer	
Diagnostic Screen Enabled	On/Off		Off	
Test Pushbutton Enabled	On/Off		On	
Remote Menu Locked	Yes/No		No	
Operator Selection	VC, VX, VN ⁷		VN	

TABLE 3. CONTINUED

6. IRBC, IRBO - Closing Infrared Beam, Opening Infrared Beam

7. VC, VX, VN - VECTOR2, VERT-X, V400/V500

26.3. UL325 Standard Profile

Parameter Description	Unit	Minimum	Default	Maximum
Autoclose Status	On/Off		Off	
Autoclose from Fully Open	On/Off		On	
Autoclose from Partly Open	On/Off		On	
Autoclose from Partly Closed	On/Off		Off	
Autoclose Time	min:sec	00:00	0:15	04:00
Autoclose Override Time	Seconds	2	3	15
Mode of Operation	STD, REV, CON ¹		Standard	
Motor M Opening Force	Level	1	3	Max (6)
Motor M Closing Force	Level	1	3	Max (6)
Motor S Opening Force	Level	1	3	Max (6)
Motor S Closing Force	Level	1	3	Max (6)
Maximum Collisions	Collisions	1	2	2
Collision Alarm Output	Buzzer, Light, Safe Com, Sol, LED		Buzzer	
PCM ² Status	On/Off		Off	
PCM ² Type	Master, Slave, Master & Slave, Short Stop		Master Only	
PCM ² Short Stop Distance	mm of piston stroke	1	5	20
PCM ² Force	%(A)	33 (2A)	50 (3A)	100 (6A)
POM ³ Status	On/Off		Off	
POM ³ Type	Master, Slave, Master & Slave		Master Only	
POM ³ Force	%(A)	33 (2A)	50 (3A)	100 (6A)
Leaf Delay Status	On/Off		Off	
Leaf Delay	mm of piston stroke	1	10	250
Opening Speed	mm/sec	10	32	33

TABLE 4

1. STD, REV, CON (Modes of Operation) - Standard, Reversing, Condominium
2. PCM - Positive Close Mode
3. POM - Positive Open Mode

26.3. UL325 Standard Profile (continued)

Parameter Description	Unit	Minimum	Default	Maximum
Closing Speed	mm/sec	10	32	33
Ramp-up Distance	mm of piston stroke	20	30	100
Ramp-down Distance	mm of piston stroke	30	50	100
Crawl Distance	mm of piston stroke	5	5	100
Push Force Limit	Amps	5	15	15
Pre-Open Delay Time	min:sec	00:00	00:00	03:16
Pre-Close Delay Time	min:sec	00:00	00:00	03:16
TRG Stop Distance	mm of piston stroke	10	20	100
IRB Stop Distance	mm of piston stroke	10	20	100
PED Open Distance	% of piston stroke	10	30	100
PED Autoclose Time	min:sec	00:00	00:05	04:00
PED Pre-Open Delay Time	min:sec	00:00	00:02	04:00
PED Pre-Close Delay Time	min:sec	00:00	00:00	04:00
Gate Lock Enabled	Yes/No		No	
Gate Lock Type	Magnetic/Striker		Striker	
Gate Lock Pre-Release Time	Seconds	0.0	0.0	24.0
Gate Lock Release Time	Seconds	0.1	1.0	24.0
Gate Lock Location	CLS, OPN, BTH ⁴		Close Only	
Gate Lock Drive Type	AC, DC		AC	
Courtesy Light Time	h:mm:ss	0:00:04	0:02:00	9:59:59
Courtesy Light Profile	CUR, PFA, PFB, PFC ⁵		Courtesy	

TABLE 4. CONTINUED

4. CLS, OPN, BTH - Closed Position, Open Position, Both (Open & Closed Positions)

5. CUR, PFA, PFB, PFC - Courtesy, Profile A, Profile B, Profile C

26.3. UL325 Standard Profile



Parameter Description	Unit	Minimum	Default	Maximum
PIRAC Enabled	On/Off		Off	
IR Beam Test Enabled	On/Off		Off	
IR Beam Test	IRBC, IRBO, IRBO & IRBC ⁶		IRBC Only	
IRBO acts as IRBC	On/Off		Off	
IRB Ambush Alarm	On/Off		Off	
IRB Ambush Alarm Hold-Off Time	h:mm:ss	0:01:00	0:01:00	4:00:00
IRB Break-In Alarm	On/Off		Off	
IRB Alarms Output	Buzz, Light, Safe Com, Sol, LED		Buzzer	
Diagnostic Screen Enabled	On/Off		Off	
Test Pushbutton Enabled	On/Off		Off	
Remote Menu Locked	Yes/No		No	
Operator Selection	VC, VX, VN ⁷		VN	

TABLE 4. CONTINUED

6. IRBC, IRBO - Closing Infrared Beam, Opening Infrared Beam

7. VC, VX, VN - VECTOR2, VERT-X, V400/V500

27. Description of Terminal Functions

S Sens1	Slave Motor (MTR S). Connects to the thin PURPLE wire of the Slave Motor.	
S Sens2	Slave Motor (MTR S). Connects to the thin BLUE wire of the Slave Motor.	
M Sens1	Master Motor (MTR M). Connects to the thin PURPLE wire of the Master Motor.	
M Sens2	Master Motor (MTR M). Connects to the thin BLUE wire of the Master Motor.	
Sens +	Operator sensor power connection. A 5V output for connecting to the thin RED sensor wire on both the MTR M and MTR S operators.	
Sens -	Operator sensor power connection. A 0V output for connecting to the thin BLACK sensor wire on both the MTR M and MTR S operators.	
Safe CLS	Closing Beam Safety Input. (A normally-closed potential-free input.) As long as a connection between this input and Com is maintained the Controller will behave normally. When this connection is broken it will prevent the gate from closing if it is stationary, and will stop and reverse the gate if it is closing. This input has no effect if the gate is opening.	
		If the Safe CLS function is not required a link must be fitted between Safe CLS and Com for the Controller to operate normally. ¹
Safe OPN	Opening Beam Safety Input. (A normally-closed potential-free input.) For as long as a connection between this input and Com is maintained the Controller will behave normally. When this connection is broken it will prevent the gate from opening if it is stationary, and will stop and partially reverse the gate if it is opening. This Input has no effect if the gate is closing.	
		If the Safe Open and reverse functions are not required, a link must be fitted between safe Open and Com for the Controller to operate normally. ¹
	<p>1. When setting up the Controller for the first time or after a full reset back to the Factory Default settings has been performed, the system will electronically override the Safety Inputs and allow the system to function without the links. However, if safeties are connected to either or both inputs, thereafter there must be a normally-closed circuit maintained for the system to operate correctly. I.e. if Safety Beams are fitted and then removed, the circuit which is affected must be replaced with a wire link to create a normally-closed circuit.</p>	
LCK/STP	Holiday Lockout. (A normally-closed potential-free input.) For as long as a connection between this input and Com is maintained, the Controller will behave normally. But, when this connection to Com is broken all inputs are inhibited.	
		If the LCK function is not required a link must be fitted between LCK and Com.

TRG	Trigger input. (A normally-open potential-free input.) Momentarily connecting this input to Com will cause the gate to open or close depending on the operating mode selected. For more information, see the Autoclose feature and Modes of Operation .
PED	Pedestrian Opening input. (A normally-open potential-free input.) Momentarily connecting this input to Com will cause one gate to open to the Pedestrian open position. For more information, refer to the Pedestrian feature .
FRX	Free-exit input. (A normally-open potential-free input.) Momentarily connecting this input to Com will cause a gate which is closed, or closing, to open or re-open. If the gate is open, the signal has no effect other than to reset the Autoclose Timer (if selected.) Free-exit (FRX) never initiates a closing cycle. The only way to close a gate, if only the FRX input is used, is to activate the Autoclose feature on the Controller. Please refer to page 40.
LIT	LIT Activates the Pillar Light output. (A normally-open potential-free input.) Momentarily connecting this input to Com will cause the LIGHT relay to energise for a period of time as set in the Courtesy Light Timer menu. If the connection is made for a period exceeding 3 seconds the Pillar Light Relay will latch and remain latched indefinitely until a new momentary connection to Com is made.
LED	External gate status indicator. (A low-current output signal.) An output terminal which provides a low-current drive (approx. 4.5V DC, 20mA) to an LED which can be used to indicate the gate status remotely. If more LEDs are required, it is necessary to fit the CP78 MULTI-LED driver card. For more details on the feedback about the status of the gate provided by the Status LED, refer to page 69.
Com	The Common termination point. All trigger signals etc., have their return path to one of the Com terminals.
Aux 12V	Auxiliary power connection. Provides a +12V DC supply for auxiliary equipment such as a radio receiver, Safety Beams, etc. It is linked directly to the battery positive via a 3A resettable fuse.
Safe Com	Used for switching the power supply to the Safety Beam transmitter. If automatic beam testing is required, the negative power supply connection of the beam transmitter must be wired to this point.
Sol	Solenoid strike or magnetic lock. A solenoid strike lock or magnetic lock can be connected between 12V and Sol. Note that the maximum current draw allowed for the lock is 2A. Should the solenoid lock or magnetic lock exceed this current rating it is necessary to use an interposing relay.

		<p>Particularly with magnetic locks, ensure that the steady state current draw calculated over a 24 hour period and added to this, the quiescent current draw of the Controller, other peripherals and the usage of the motors, does not exceed the current delivered by the charger. If necessary, fit a separate supply to power the lock using an interposing relay connected to the Sol input.</p>
Light	<p>Pillar Light connection. These two terminals provide a normally-open potential-free contact which is generally used to switch on a Pillar Light (Courtesy Light). This contact is fuse-protected - refer to page 34 for Fuse Protection details.</p>	
Batt +	<p>Positive battery connection. (Battery terminal normally indicated as + or RED)</p>	
Batt -	<p>Negative battery connection. (Battery terminal normally indicated as - or BLACK)</p>	
MTR M+	<p>Master Motor power connection. (Thick BLUE wire)</p>	
MTR M-	<p>Master Motor power connection. (Thick BLACK wire)</p>	
MTR S+	<p>Slave Motor power connection. (Thick BLUE wire)</p>	
MTR S-	<p>Slave Motor power connection. (Thick BLACK wire)</p>	

28. Diagnostics

28.1. Diagnostic LEDs

The Controller is fitted with diagnostic lights (LEDs) that assist with the setup and maintenance of the gate.

Figure 36 below provides the description and purpose of the indicator lights also indicating the location on the Controller.

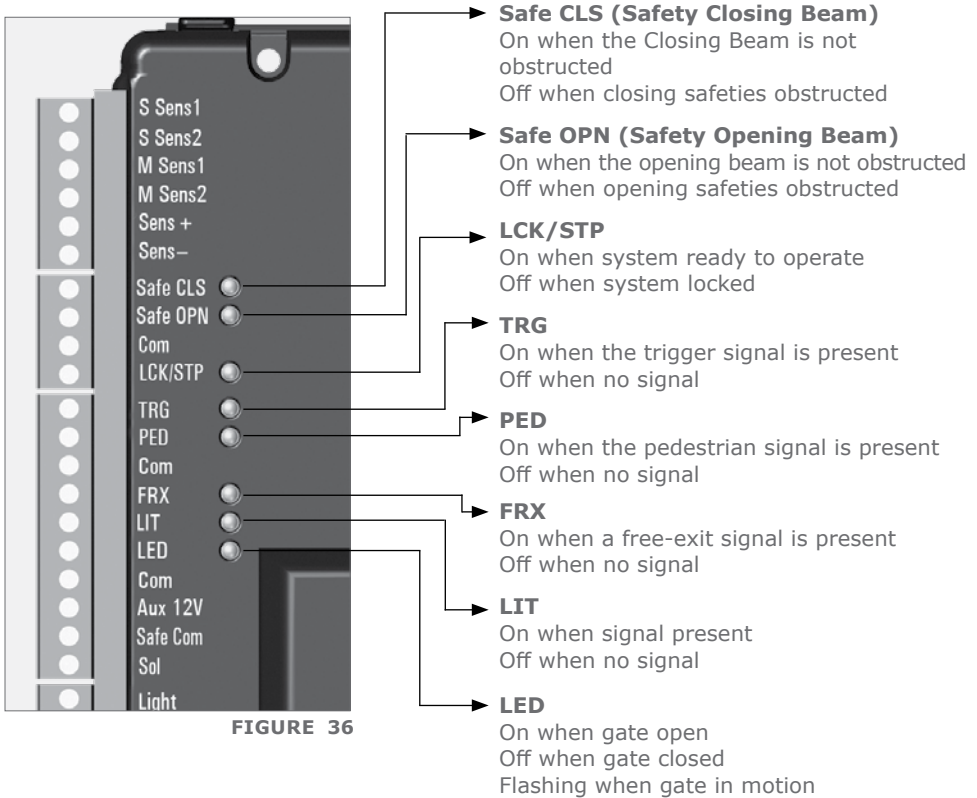

FIGURE 36

See Table 5 on page 69 for LED diagnostic features.

28.2. Gate Status LED Indication

Slow regular flash	Gate is opening
Fast regular flash	Gate is closing
One flash every two seconds	Courtesy Light latched on
Two flashes every two seconds	Mains Failure
Three flashes every two seconds	Battery-low
Four flashes every two seconds	Collision Shutdown
	Multiple Collisions have occurred

TABLE 5

28.3. LCD Display

The LCD display shows useful information regarding the status of the system



FIGURE 37. CONTROLLER SCREEN

28.3.1. Battery icon

Indicates the state of charge of the battery:

- Four solid bars = full capacity
- Two solid bars = 50% capacity
- No solid bars, with the icon flashing = battery empty

28.3.2. Mains icon

Displays the presence/absence of mains voltage:

- Plug solid = mains present and battery charging
- Plug hollow and flashing = no mains present and battery not charging

28.3.3. Autoclose information

- Displays the state of the Autoclose function
- Displays OFF if Autoclose is not selected
- OVR if Autoclose is overridden
- Remaining Autoclose time if Autoclose is active

28.3.4. Pillar Light information

- Displays the remaining light time if Courtesy Light Mode is selected
- Pre-flashing Mode is displayed if Pre-flash is selected
- LIT will be indicated if the Pillar Light has been turned on permanently

28.3.5. Onboard receiver information

Displays the current input being activated by the onboard receiver

28.3.6. Status information

Displays useful information regarding the status of the gate

28.4. Buzzer Feedback

The **V-Series Controller** is equipped with an onboard buzzer which is used for various features and functions on the Controller. One of the functions it provides is audible diagnostic feedback as detailed.

	Priority	Number of beeps	Fault type	Gate continues to operate	User can correct error
Break-in Alarm	1	1 beep periodically for 30 seconds	Alarm	N/A	N/A
Ambush Alarm	2	Periodic until condition is cleared by user	Alarm	N/A	N/A
Battery-low	3	3 beeps periodically for 30 seconds	Power system fault	Yes ¹	Yes
Multiple Collision	4	Periodic until condition is cleared by user (500/500ms)	Collision	No	Yes
Holiday Lockout	5	5 beeps after trigger activation	User	No	Yes

TABLE 6

1. Gates will close fully and then shut down for two minutes

29. Installation Handover

Once the installation has been successfully completed and tested, it is important for the installer to explain the operation and safety requirements of the system.

NEVER ASSUME THE USER KNOWS HOW TO SAFELY OPERATE AN AUTOMATED GATE!

Even if the user has used one before, it does not mean he knows how to SAFELY operate it. Make sure that the user fully understands the following safety requirements before finally handing over the site.

The following needs to be understood by the user:

- How to operate the manual release mechanism. **(Show them how by demonstration)**
 - How the obstruction detection and all other safety features work. **(Show them how by demonstration)**
 - All the features and benefits of the operator, i.e. Beams, etc.
 - All the safety considerations associated with operating an automated gate. The user should be able to pass this knowledge on to all other users of the automated system and must be made aware of this responsibility.
- Do not activate the gate operator unless you can see it and can determine that its area of travel is clear of people, pets, or other obstructions
 - **NO ONE MAY CROSS THE PATH OF A MOVING GATE.** Always keep people and objects away from the gate and its area of travel
 - **NEVER LET CHILDREN OPERATE OR PLAY WITH THE GATE CONTROLS,** and do not allow children or pets near the gate area
 - Be careful with moving parts and avoid close proximity to areas where fingers or hands could be pinched
 - Secure all easily-accessible gate operator controls in order to prevent unauthorised use of the gate
 - Keep the automated gate system properly maintained, and ensure that all working areas are free of debris and other objects that could affect the gate operation and safety
 - On a monthly basis, check the obstruction detection system and safety devices for correct operation
 - All repair and service work to this product must be done by a suitably qualified person
 - This product was designed and built strictly for the use indicated in this documentation. Any other use, not expressly indicated here, could compromise the good condition/operation of the product and/or be a source of danger!



Centurion Systems (Pty) Ltd does not accept any liability caused by improper use of the product, or for use other than that for which the automated system was designed. **Ensure that the customer is in possession of the User Guide and that you have completed the installation details in the back of the User Guide.**



www.centsys.com

Connect with us on:

 facebook.com/centurionsystems

 YouTube.com/centurionsystems

 [@askcenturion](https://twitter.com/askcenturion)

 centurion.systems

Subscribe to the newsletter: www.centsys.com/subscribe

Call Centurion Systems (Pty) Ltd • South Africa

Head Office: +27 11 699 2400

Call Technical Support: +27 11 699 2481

from 07h00 to 18h00 (UTC+2)

www.centsys.com.au

Call: 1300 CENTSYS (1300 236 879)

**After Hours International Technical Support Call Centre
+27 11 699 2481 (16:00 to 02:00 - Australian Eastern Time)**

E&OE Centurion Systems (Pty) Ltd reserves the right to change any product without prior notice

All product and brand names in this document that are accompanied by the ® symbol are registered trademarks in South Africa and/or other countries, in favour of Centurion Systems (Pty) Ltd, South Africa.

The CENTURION and CENTSYS logos, all product and brand names in this document that are accompanied by the TM symbol are trademarks of Centurion Systems (Pty) Ltd, in South Africa and other territories; all rights are reserved. We invite you to contact us for further details.



**DOC num: 1228.D.01.0012_12042022
SAP num: DOC12283V100**